

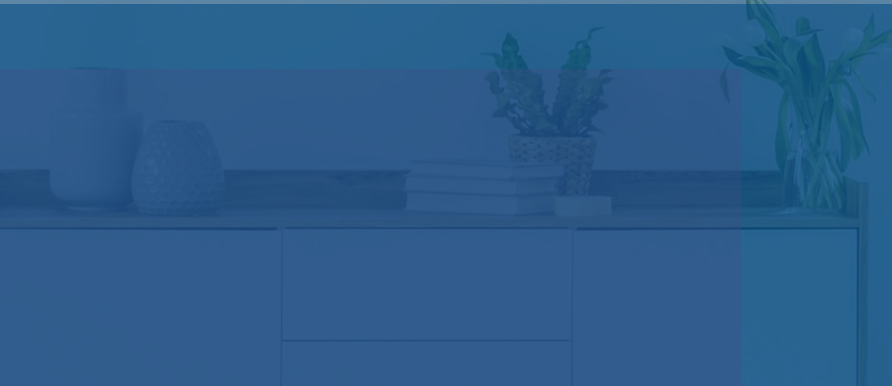

TARIFA CLIMATIZACIÓN 2020





En Gases Fuensanta S.L. llevamos 10 años acompañando a profesionales en todos sus proyectos.



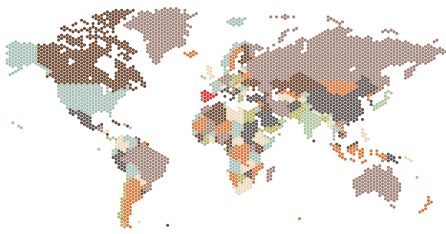

Índice



Climatización

- 4 Gree
- 8 Mitsubishi Electric
- 12 LG
- 14 Fujitsu

Aeroterminia

- 19 Gree
- 23 Mitsubishi Electric
- 25 LG
- 27 Gree Fancoil

Ventilación

- 29 Recuperadores de calor
- 29 Cajas de ventilación
- 30 Accesorios
- 31 Tubo flexible
- 31 Conducto helicoidal
- 31 Accesorios
- 34 Rejillas
- 35 Difusores
- 35 Bocas extractoras
- 35 Largueros
- 36 Fibra URSA y accesorios
- 37 Sistema de zonas y componentes Airzone
- 38 Sistema de zonas y componentes MYSAir

Montaje Split

- 39 Material eléctrico
- 40 Escaleras y elevadores
- 41 Bombas de condensados
- 42 Tubería PVC y accesorios
- 43 Fijación
- 44 Soportes antivibración
- 45 Componentes
- 46 Herramientas
- 47 Canaleta
- 48 Tubería de cobre
- 50 Accesorios de cobre

Herramientas aire acondicionado y refrigeración

- 52 Bombas de vacío
- 53 Básculas
- 54 Equipos de recuperación y reciclaje
- 55 Abocardadores
- 56 Ensanchatubos, cortatubos y doblatubos
- 57 Puente manómetros
- 58 Mangueras
- 58 Aceites
- 59 Pruebas estanqueidad

Gases refrigerantes

- 60 Gases refrigerantes
- 60 Tipos de envase
- 61 Gestor de residuos
- 62 Gases industriales botella pequeña

Soldadura reg corte

- 64 Equipos autónomos soldadura
- 65 Sopletes soldar
- 66 Sopletes corte
- 67 Válvulas de seguridad
- 67 Mangueras
- 68 Accesorios
- 69 Regulación

Generadores de ozono

- 71 Soldadura MIG
- 72 Soldadura TIG
- 74 Accesorios soldadura
- 75 Aportaciones soldadura
- 76 Maquinaria soldadura
- 78 MESSER Soldadura eléctrica

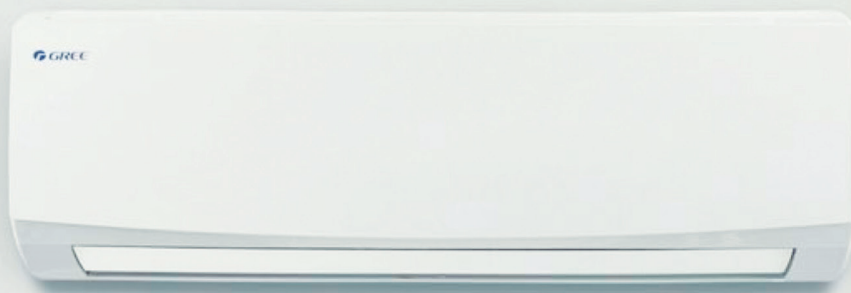



LOMO

Split - Gama Doméstica



P.Netto
32 €

Código	Modelo	P.Netto	Frig / h	SEER	SCOP	Int (mm)	Ext (mm)	Conex.	Long. Prec. (m)	Carg. Ad. (g/m)	L.V (m)	L.Mx (m)
LOMO9R32	LOMO 9 R32	255 €	2150	A++	A+++	790x275x200	776x540x320	1/4"-3/8"	5	20	10	15
LOMO12R32	LOMO 12 R32	260 €	2752	A++	A+++	790x275x200	848x596x320	1/4"-3/8"	5	16	10	20
LOMO18R32	LOMO 18 R32	499 €	3956	A++	A+++	970x300x224	842x596x320	1/4"-3/8"	5	16	10	20
LOMO24R32	LOMO 24 R32	669 €	5547	A++	A++	970x300x224	955x700x396	1/4"-5/8"	5	40	10	25

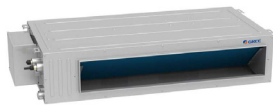

U-MATCH

Conductos - Gama Comercial



P.Netto
42 €

Código	Modelo	P.Netto	Frig / h	SEER	SCOP	Int (mm)	Ext (mm)	Conex.	Long. Prec. (m)	Carg. Ad. (g/m)	L.V (m)	L.Mx (m)
UMCDT18R32	UM CDT 18 R32	710 €	4300	A++	A+	1000x200x450	818x596x302	1/4"-1/2"	5	16	20	35
UMCDT24R32	UM CDT 24 R32	769 €	6020	A++	A+	900x260x635	892x698x340	3/8"-5/8"	5	40	25	50
UMCDT30R32	UM CDT 30 R32	940 €	7310	A++	A+	900x260x635	892x698x340	3/8"-5/8"	5	40	25	50
UMCDT36R32	UM CDT 36 R32	1.115 €	8600	A++	A+	1000x300x700	940x820x460	3/8"-5/8"	5	40	30	65
UMCDT42R32	UM CDT 42 R32	1.355 €	10406	-	-	1400x300x700	940x820x460	3/8"-5/8"	5	40	30	75
UMCDT48R32	UM CDT 48 R32	1.430 €	11524	-	-	1400x300x700	940x820x460	3/8"-5/8"	7,5	40	30	75

Modelos Trifásicos

UMCDT36R32-3F	UM CDT 36 3F R32	1.359 €	8600	A++	A+	1000x300x700	940x820x460	3/8"-5/8"	5	40	30	65
UMCDT42R32-3F	UM CDT 42 3F R32	1.385 €	10406	-	-	1400x300x700	940x820x460	3/8"-5/8"	5	40	30	75
UMCDT48R32-3F	UM CDT 48 3F R32	1.520 €	11524	-	-	1400x300x700	940x820x460	3/8"-5/8"	7,5	40	30	75
UMCDT60R32-3F	UM CDT 60F R32	1.749 €	13760	-	-	1400x300x700	900x1345x443	3/8"-5/8"	7,5	40	30	75



U-MATCH

Cassette - Gama Comercial



P.Netto
42 €

Código	Modelo	P.Netto	Frig / h	SEER	SCOP	Int (mm)	Ext (mm)	Conex.	Long. Prec. (m)	Carg. Ad. (g/m)	L.V (m)	L.Mx (m)
UMCST18R32	UM CST 18 R32	725 €	4300	A+	A+	570x265x570	818x596x302	1/4"-1/2"	5	16	20	35
UMCST24R32	UM CST 24 R32	859 €	6020	A++	A	840x240x840	892x698x340	3/8"-5/8"	5	40	25	50
UMCST30R32	UM CST 30 R32	1.020 €	7310	A++	A+	840x240x840	920x790x370	3/8"-5/8"	5	40	25	50
UMCST36R32	UM CST 36 R32	1.179 €	8600	A++	A+	840x240x840	940x820x460	3/8"-5/8"	5	40	30	65
UMCST42R32	UM CST 42 R32	1.305 €	10406	-	-	840x290x840	940x820x460	3/8"-5/8"	5	40	30	65
UMCST48R32	UM CST 48 R32	1.489 €	11524	-	-	840x290x840	940x820x460	3/8"-5/8"	7,5	40	30	75

Modelos Trifásicos

UMCST36R32-3F	UM CST 36 3F R32	1.409 €	8600	A++	A+	840x240x840	940x820x460	3/8"-5/8"	5	40	30	75
UMCST42R32-3F	UM CST 42 3F R32	1.485 €	10406	-	-	840x290x840	940x820x460	3/8"-5/8"	5	40	30	75
UMCST48R32-3F	UM CST 48 3F R32	1.635 €	11524	-	-	840x290x840	940x820x460	3/8"-5/8"	7,5	40	30	75
UMCST60R32-3F	UM CST 60 3F R32	1.675 €	12470	-	-	840x290x840	900x1345x460	3/8"-5/8"	7,5	40	30	75



U-MATCH

Suelo-Techo - Gama Comercial



P.Neto
42€

Código	Modelo	P.Neto	Frig / h	SEER	SCOP	Int (mm)	Ext (mm)	Conex.	Long. Prec. (m)	Carg. Ad. (g/m)	L.V (m)	L.Mx (m)
UMST18R32	UM ST 18 R32	735 €	4300	A++	A+	870 x 235 x 665	818 x 596 x 302	1/4"-1/2"	5	16	20	35
UMST24R32	UM ST 24 R32	820 €	6020	A++	A+	1200 x 235 x 665	892 x 698 x 340	3/8"-5/8"	5	40	25	50
UMST30R32	UM ST 30 R32	1.069 €	7310	A++	A+	1200 x 235 x 665	920 x 790 x 370	3/8"-5/8"	5	40	25	50
UMST36R32	UM ST 36 R32	1.219 €	8600	A++	A+	1200 x 235 x 665	940 x 820 x 460	3/8"-5/8"	5	40	30	65
UMST42R32	UM ST 42 R32	1.395 €	10406	-	-	1570 x 235 x 665	940 x 820 x 460	3/8"-5/8"	5	40	30	75
UMST48R32	UM ST 48 R32	1.420 €	11524	-	-	1570 x 235 x 665	940 x 820 x 460	3/8"-5/8"	7,5	40	30	75

Modelos Trifásicos

UMST36R32-3F	UM ST 36 3F R32	1.439 €	8600	A++	A+	1200 x 235 x 665	940 x 820 x 460	3/8"-5/8"	5	40	30	65
UMST42R32-3F	UM ST 42 3F R32	1.525 €	10406	-	-	1570 x 235 x 665	940 x 820 x 460	3/8"-5/8"	5	40	30	75
UMST48R32-3F	UM ST 48 3F R32	1.615 €	11524	-	-	1570 x 235 x 665	940 x 820 x 460	3/8"-5/8"	7,5	40	30	75
UMST60R32-3F	UM ST 60 3F R32	1.750 €	13760	-	-	1570 x 235 x 665	900 x 1345 x 443	3/8"-5/8"	7,5	40	30	75



FREE MATCH - LOMO

MultiSplit - Unidades Interiores



P.Neto
32€

Código	Modelo	P.Neto	Frig / h	Medidas (mm)	Conex.
FMLOMO7R32	FM LOMO 7 R32	109 €	1806	790 x 275 x 200	1/4"-3/8"
FMLOMO9R32	FM LOMO 9 R32	115 €	2150	790 x 275 x 200	1/4"-3/8"
FMLOMO12R32	FM LOMO 12 R32	119 €	2752	790 x 275 x 200	1/4"-3/8"
FMLOMO18R32	FM LOMO 18 R32	135 €	3956	970 x 300 x 224	1/4"-3/8"
FMLOMO24R32	FM LOMO 24 R32	260 €	5293	970 x 300 x 224	1/4"-5/8"



FREE MATCH

MultiSplit - Unidades Exteriores



Código	Modelo	P.Neto	Frig / h	SEER	SCOP	Medidas (mm)	Conex.	Long. Prec. (m)	Carg. Ad. (g/m)	L.V (m)	L.Mx (m)
FM14R32	FM 14 R32 2 x 1	535 €	3526	A++	A+	899 x 596 x 378	2 x 1/4"-3/8"	10	20	5	20
FM18R32	FM 18 R32 2 x 1	565 €	4472	A++	A+	899 x 596 x 378	2 x 1/4"-3/8"	10	20	5	20
FM21R32	FM 21 R32 3 x 1	659 €	5246	A++	A+	955 x 700 x 396	2 x 1/4"-3/8"	30	20	10	60
FM24R32	FM 24 R32 3 x 1	705 €	6106	A++	A+	980 x 790 x 427	3 x 1/4"-3/8"	30	20	10	60
FM28R32	FM 28 R32 4 x 1	745 €	6880	A++	A+	980 x 790 x 427	4 x 1/4"-3/8"	40	20	10	70
FM36R32	FM 36 R32 4 x 1	1.160 €	9030	A++	A+	1088 x 1103 x 440	4 x 1/4"-3/8"	40	20	15	75
FM42R32	FM 42 R32 5 x 1	1.269 €	10320	A++	A+	1088 x 1103 x 440	4 x 1/4"+3/8" 2 x 3/8"+1/2"+5/8"	40	20	15	75



T-FRESH
Columna - Gama Comercial



FRESH WIND
Columna - Gama Comercial

Código	Modelo	P.Neto	Frig / h	SEER	SCOP	Int (mm)	Ext (mm)	Conex.	Long. Prec. (m)	Carg. Ad. (g/m)	L.V (m)	L.Mx (m)
T-FRESH24R32	T-FRESH 24	1149 €	6192	A++	A+	507x1770x320	976x700x396	1/4"-5/8"	5	40	10	25
T-FRESH48R32	T-FRESH 48	1810 €	10320	A+	A	580x1870x400	1018x1107x440	3/8"-5/8"	5	50	10	25
FRESHW48-3F	FRESH WIND 48 3F	1769 €	10320	A	A	580x1870x400	1018x1107x440	3/8"-5/8"	5	50	10	25



SHARK
Caravanas - Gama Comercial



Código	Modelo	P.Neto	Frig / h	SEER	SCOP	Int (mm)	Ext (mm)
SHARK120	SHARK 120	655 €	3010	A	A+	667x96x497	1018x259x650



COOLANI
Aire de ventana - Gama Comercial



Código	Modelo	P.Neto	Frig / h	SEER	SCOP	Medidas (mm)
COOLANI9R32	COOLANI 9	400 €	2322	-	-	560 x 375 x 708
COOLANI12R32	COOLANI 12	445 €	3139	-	-	660 x 428 x 700



CORTINA DE AIRE
Cortinas - Gama Comercial

Código	Modelo	P.Neto	Caudal de aire	Medidas (mm)	Presión Sonora
CORT110	CORT 110	129 €	1200 (m³/h)	900 x 193 x 215	59 (dB(A))
CORT140	CORT 140	145 €	1650 (m³/h)	1200 x 193 x 215	61 (dB(A))

BIG CDT 20 - 25

BIG CDT 30 - 40



BIG DUCT
Conductos - Gama Industrial



Código	Modelo	P.Neto	Frig / h	SEER	SCOP	Int (mm)	Ext (mm)	Conex.	Long. Prec. (m)	Carg. Ad. (g/m)	L.V (m)	L.Mx (m)
BIGCDT20	BIG CDT 20	2.685 €	1720	B	B	1460x365x790	940x1430x320	3/8"-3/4"	0	54	30	50
BIGCDT25	BIG CDT 25	3.129 €	2150	C	A	1690x440x870	940x1615x460	3/8"-7/8"	0	54	30	50
BIGCDT30	BIG CDT 30	3.445 €	2580	B	B	1690x440x870	940x1615x460	1/2"-1"	0	110	30	50
BIGCDT40	BIG CDT 40	4.820 €	3440	C	B	1680x600x900	2x940x1430x320	3/8"-3/4"	0	108	30	50



MSZ-AP
 Split - Gama Doméstica

Código	Modelo	P.Neto	Frig / h	SEER	SCOP	Int (mm)	Ext (mm)	Conex.	Long. Prec. (m)	Carg. Ad. (g/m)	L.V (m)	L.Mx (m)
MSZAP25VGK	MSZ-AP25VG(K)	510 €	2150	A+++	A+++	299 x 798 x 219	550 x 800 x 285	1/4"-3/8"	7	20	12	20
MSZAP35VGK	MSZ-AP35VG(K)	560 €	3010	A+++	A+++	299 x 798 x 219	550 x 800 x 285	1/4"-3/8"	7	20	12	20
MSZAP42VGK	MSZ-AP42VG(K)	910 €	3612	A++	A+++	299 x 798 x 219	550 x 800 x 285	1/4"-3/8"	7	20	12	20
MSZAP50VGK	MSZ-AP50VG(K)	1.200 €	4300	A++	A+++	299 x 798 x 219	714 x 800 x 285	1/4"-3/8"	7	20	12	20
MSZAP60VGK	MSZ-AP60VG(K)	1.369 €	5246	A++	A+++	325 x 1100 x 257	714 x 800 x 285	1/4"-1/2"	15	20	15	30
MSZAP71VGK	MSZ-AP71VG(K)	1.870 €	6106	A++	A+++	325 x 1100 x 257	880 x 840 x 330	1/4"-1/2"	15	20	15	30

MSZ-BT
 Split - Gama Doméstica

Código	Modelo	P.Neto	Frig / h	SEER	SCOP	Int (mm)	Ext (mm)	Conex.	Long. Prec. (m)	Carg. Ad. (g/m)	L.V (m)	L.Mx (m)
MSZBT25VGK	MSZ-BT25VGK	445 €	2150	A++	A+++	280 x 838 x 235	538 x 699 x 249	1/4"-3/8"	7	20	12	20
MSZBT35VGK	MSZ-BT35VGK	480 €	3010	A++	A+++	280 x 838 x 235	538 x 699 x 249	1/4"-3/8"	7	20	12	20
MSZBT50VGK	MSZ-BT50VGK	965 €	3612	A++	A+++	280 x 838 x 235	550 x 800 x 285	1/4"-1/2"	7	20	12	20

MSZ-HR
 Split - Gama Doméstica

P.Neto
59€

Código	Modelo	P.Neto	Frig / h	SEER	SCOP	Int (mm)	Ext (mm)	Conex.	Long. Prec. (m)	Carg. Ad. (g/m)	L.V (m)	L.Mx (m)
MSZHR25VF	MSZ-HR25VF	375 €	2150	A++	A+++	280 x 838 x 228	538 x 699 x 249	1/4"-3/8"	7	20	12	20
MSZHR35VF	MSZ-HR35VF	415 €	2924	A++	A+++	280 x 838 x 228	538 x 699 x 249	1/4"-3/8"	7	20	12	20
MSZHR42VF	MSZ-HR42VF	635 €	3612	A++	A+++	280 x 838 x 228	550 x 800 x 285	1/4"-3/8"	7	20	12	20
MSZHR50VF	MSZ-HR50VF	725 €	4300	A++	A+++	280 x 838 x 228	550 x 800 x 285	1/4"-3/8"	7	20	12	20
MSZHR71VF	MSZ-HR71VF	1.140 €	6106	A++	A+++	305 x 923 x 263	714 x 800 x 285	1/4"-1/2"	15	20	12	20

MXZ MSZ-HR
 MultiSplit - Unidades Interiores

P.Neto
59 €

Código	Modelo	P.Neto	Frig / h	Medidas (mm)	Conex.
MSZHR25MULTI	MSZ-HR25VF	205 €	2150	280x838x228	1/4"-3/8"
MSZHR35MULTI	MSZ-HR35VF	219 €	2924	280x838x228	1/4"-3/8"

MXZ-HA-VF
 MultiSplit - Unidades Exteriores

Código	Modelo	P.Neto	Frig / h	SEER	SCOP	Medidas (mm)	Conex.	Long. Prec. (m)	Carg. Ad. (g/m)	L.V (m)	L.Mx (m)
MXZ2HA40VF	MXZ-2HA40VF 2 x 1	620 €	3440	A++	A+	550x800(+69)x285(+59,5)	2x1/4"-3/8"	-	-	15	30
MXZ2HA50VF	MXZ-2HA50VF 2 x 1	705 €	4300	A++	A+	550x800(+69)x285(+59,5)	2x1/4"-3/8"	-	-	15	30
MXZ3HA50VF	MXZ-3HA50VF 3 x 1	850 €	4300	A++	A+	710x840x330(+66)	3x1/4"-3/8"	-	-	15	50

MSPEZ
 Conductos - Gama Comercial

P.Neto
59 €

Código	Modelo	P.Neto	Frig / h	SEER	SCOP	Int (mm)	Ext (mm)	Conex.	Long. Prec. (m)	Carg. Ad. (g/m)	L.V (m)	L.Mx (m)
MSPEZ50VJA	MSPEZ-50VJA	1.169 €	4300	A++	A+	250x900x732	714x800x285	1/4"-1/2"	7	20	30	30
MSPEZ60VJA	MSPEZ-60VJA	1.225 €	5246	A+	A+	250x1100x732	880x840x330	1/4"-5/8"	7	20	30	30
MSPEZ71VJA	MSPEZ-71VJA	1.459 €	6106	A+	A	250x1100x732	880x840x330	3/8"-5/8"	7	40	30	30
MSPEZ100VJA	MSPEZ-100VJA	2.025 €	8170	A	A+	250x1400x732	981x1050x330	3/8"-5/8"	30	40	30	55
MSPEZ125VJA	MSPEZ-125VJA	2.445 €	10406	-	-	250x1400x732	981x1050x330	3/8"-5/8"	30	40	30	65
MSPEZ140VJA	MSPEZ-140VJA	2.860 €	11524	-	-	250x1600x732	981x1050x330	3/8"-5/8"	30	40	30	65

Modelos Trifásicos

MSPEZ100YJA	MSPEZ-100YJA	2.160 €	8170	A	A+	250x1400x732	981x1050x330	3/8"-5/8"	30	40	30	55
MSPEZ125YJA	MSPEZ-125YJA	2.595 €	10406	-	-	250x1400x732	981x1050x330	3/8"-5/8"	30	40	30	65
MSPEZ140YJA	MSPEZ-140YJA	3.069 €	11524	-	-	250x1600x732	981x1050x330	3/8"-5/8"	30	40	30	65

MGPEZ
 Conductos - Gama Comercial

P.Netto
59€

Código	Modelo	P.Netto	Frig / h	SEER	SCOP	Int (mm)	Ext (mm)	Conex.	Long. Prec. (m)	Carg. Ad. (g/m)	L.V (m)	L.Mx (m)
MGPEZ71VJA	MGPEZ-71VJA	1.169 €	6106	A	A	250 x 1100 x 732	880 x 840 x 330	3/8"-5/8"	30	40	30	30
MGPEZ100VJA	MGPEZ-100VJA	1.679 €	8170	A	A	250 x 1400 x 732	981 x 1050 x 330	3/8"-5/8"	30	40	30	30
MGPEZ125VJA	MGPEZ-125VJA	1.760 €	10406	-	-	250 x 1400 x 732	981 x 1050 x 330	3/8"-5/8"	30	40	30	40
MGPEZ140VJA	MGPEZ-140VJA	2.590 €	11524	-	-	250 x 1600 x 732	981 x 1050 x 330	3/8"-5/8"	30	40	30	40

Modelos Trifásicos

MGPEZ100YJA	MGPEZ-100YJA	1.779 €	8170	A	A	250 x 1400 x 732	981 x 1050 x 330	3/8"-5/8"	30	40	30	30
MGPEZ125YJA	MGPEZ-125YJA	2.029 €	10406	-	-	250 x 1400 x 732	981 x 1050 x 330	3/8"-5/8"	30	40	30	40
MGPEZ140YJA	MGPEZ-140YJA	2.652 €	11524	-	-	250 x 1600 x 732	981 x 1050 x 330	3/8"-5/8"	30	40	30	40

MGPLZ
 Cassettes - Gama Comercial

P.Netto
59€

Código	Modelo	P.Netto	Frig / h	SEER	SCOP	Int (mm)	Ext (mm)	Conex.	Long. Prec. (m)	Carg. Ad. (g/m)	L.V (m)	L.Mx (m)
MGPLZ71VEA	MGPLZ-71VEA	1.439 €	6106	A+	A	258 x 840 x 840	880 x 840 x 330	3/8"-5/8"	30	40	30	30
MGPLZ100VEA	MGPLZ-100VEA	1.680 €	8170	A+	A+	298 x 840 x 840	981 x 1050 x 330	3/8"-5/8"	30	40	30	30
MGPLZ125VEA	MGPLZ-125VEA	1.965 €	10406	-	-	298 x 840 x 840	981 x 1050 x 330	3/8"-5/8"	30	40	30	40
MGPLZ140VEA	MGPLZ-140VEA	2.605 €	11524	-	-	298 x 840 x 840	981 x 1050 x 330	3/8"-5/8"	30	40	30	40

Modelos Trifásicos

MGPLZ100YEA	MGPLZ-100YEA	1.790 €	8170	A+	A+	298 x 840 x 840	981 x 1050 x 330	3/8"-5/8"	30	40	30	30
MGPLZ125YEA	MGPLZ-125YEA	2.049 €	10406	-	-	298 x 840 x 840	981 x 1050 x 330	3/8"-5/8"	30	40	30	40
MGPLZ140YEA	MGPLZ-140YEA	2.675 €	11524	-	-	298 x 840 x 840	981 x 1050 x 330	3/8"-5/8"	30	40	30	40

SPEZ
 Conductos - Gama Industrial

P.Netto
59€

Código	Modelo	P.Netto	Frig / h	SEER	SCOP	Int (mm)	Ext (mm)	Conex.	Long. Prec. (m)	Carg. Ad. (g/m)	L.V (m)	L.Mx (m)
SPEZ200WYKA	SPEZ-200WYKA	4.235 €	16340	F	E	470 x 1370 x 1120	1338 x 1050 x 330	3/8"-1"	30	90	30	70
SPEZ250WYKA	SPEZ-250WYKA	4.735 €	18920	F	E	470 x 1370 x 1120	1338 x 1050 x 330	1/2"-1"	30	120	30	70



CONFORT WIFI R32

Split - Gama Doméstica



Código	Modelo	P.Neto	Frig / h	SEER	SCOP	Int (mm)	Ext (mm)	Conex.	Long. Prec. (m)	Carg. Ad. (g/m)	L.V (m)	L.Mx (m)
S09ET	S09ET	325 €	2150	A++	A+	308 x 837 x 189	495 x 717 x 230	1/4"-3/8"	7,5	20	12	15
S12ET	S12ET	335 €	2150	A++	A+	308 x 837 x 189	495 x 717 x 230	1/4"-3/8"	7,5	20	12	15
S18ET	S18ET	640 €	4300	A++	A+	345 x 998 x 210	545 x 770 x 288	1/4"-1/2"	7,5	20	12	20
S24ET	S24ET	790 €	5.676	A++	A+	345 x 998 x 210	650 x 870 x 330	1/4"-5/8"	7,5	20	12	30



CONFORT CONNECT

MultiSplit - Unidades Interiores



Código	Modelo	P.Neto	Frig / h	Medidas (mm)	Conex.
PC09SQMULTI	PC09SQ	164 €	2150	837 x 308 x 189	1/4"-3/8"
PC12SQMULTI	PC12SQ	175 €	3010	837 x 308 x 189	1/4"-3/8"



MU2R.ULO

MultiSplit - Unidades Exteriores



Código	Modelo	P.Neto	Frig / h	SEER	SCOP	Medidas (mm)	Conex.	Long. Prec. (m)	Carg. Ad. (g/m)	L.V (m)	L.Mx (m)
MU2R15	MU2R15.ULO 2 x 1	465 €	3526	A+++	A++	770 x 545 x 288	2 x 1/4"-3/8"	7,5	20	15	30
MU2R17	MU2R17.ULO 2 x 1	560 €	4042	A++	A+	770 x 545 x 288	2 x 1/4"-3/8"	7,5	20	15	30



COMPACT

Conductos - Gama Comercial



P.Netto
60€



Código	Modelo	P.Netto	Frig / h	SEER	SCOP	Int (mm)	Ext (mm)	Conex.	Long. Prec. (m)	Carg. Ad. (g/m)	L.V (m)	L.Mx (m)
CM18R	CM18R+UU18WCR	795 €	4300	A+	A	900x270x700	770x545x288	1/4"-1/2"	5	20	30	30
CM24R	CM24R+UU24WCR	940 €	5848	A+	A	900x270x700	870x650x330	3/8"-5/8"	5	35	30	35
CM30R	UM30R+UU30WCR	1.155 €	6450	A+	A	900x270x700	870x650x330	3/8"-5/8"	5	35	30	35
CM36R	UM36R+UU36WCR	1.295 €	8170	A+	A	1250x270x700	950x834x330	3/8"-5/8"	5	35	30	50

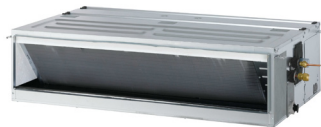

PRO

Conductos - Gama Comercial



P.Netto
60€



Código	Modelo	P.Netto	Frig / h	SEER	SCOP	Int (mm)	Ext (mm)	Conex.	Long. Prec. (m)	Carg. Ad. (g/m)	L.V (m)	L.Mx (m)
UM42R-3F	UM42R+UU42WR	1.595 €	10320	A+	A+	1250x270x700	950x1380x330	3/8"-5/8"	5	40	30	85
UM48R-3F	UM48R+UU48WR	1.949 €	11524	-	-	1250x360x700	950x1380x330	3/8"-5/8"	5	40	30	85
UM60R-3F	UM60R+UU60WR	2.620 €	12900	-	-	1250x360x700	950x1380x330	3/8"-5/8"	5	40	30	85

Modelos Trifásicos

UM36R-3F	UM36R+UU37WR	1.600 €	8170	A+	A+	1250x270x700	950x1380x330	3/8"-5/8"	5	40	30	85
UM42R-3F	UM42R+UU43WR	1.805 €	10320	A+	A+	1250x270x700	950x1380x330	3/8"-5/8"	5	40	30	85
UM48R-3F	UM48R+UU49WR	1.975 €	11524	-	-	1250x360x700	950x1380x330	3/8"-5/8"	5	40	30	85
UM60R-3F	UM60R+UU61WR	2.655 €	12900	-	-	1250x360x700	950x1380x330	3/8"-5/8"	5	40	30	85



MODELO 2020

CONFORT

Cassettes - Gama Comercial



P.Netto
60€



Código	Modelo	P.Netto	Frig / h	SEER	SCOP	Int (mm)	Ext (mm)	Conex.	Long. Prec. (m)	Carg. Ad. (g/m)	L.V (m)	L.Mx (m)
CT18F	CT18F+UUA1U10	835 €	4300	A++	A	256x570x570	545x770x288	1/4"-3/8"	5	20	30	30
CT24F	CT24F+UUB1U20	1.020 €	5848	A++	A+	204x840x840	650x870x330	1/4"-1/2"	5	20	30	30
UT30F	UT30F+UUB1U20	1.175 €	6450	A++	A+	204x840x840	650x870x330	1/4"-1/2"	5	20	30	30
UT36F	UT36F+UUC1U40	1.345 €	8170	A++	A+	288x840x840	834x950x330	3/8"-5/8"	5	35	30	50



MÍNIMO CONSUMO
MÁXIMO SILENCIO



FUJITSU

 GASES
FUENSANTA



ASY UI-KP
Split - Gama Doméstica



P.Neto
58€

22dB(A)



A++
CLASE



Código	Modelo	P.Neto	Frig / h	SEER	SCOP	Int (mm)	Ext (mm)	Conex.	Long. Prec. (m)	Carg. Ad. (g/m)	L.V (m)	L.Mx (m)
ASY25UIKP	ASY 25 UI-KP	380 €	2500	A++	A+	270 x 784 x 224	541 x 663 x 290	1/4"-3/8"	15	20	15	20
ASY35UIKP	ASY 35 UI-KP	405 €	3400	A++	A+	270 x 784 x 224	541 x 663 x 290	1/4"-3/8"	15	20	15	20



ASY UI-KL
Split - Gama Doméstica



P.Neto
105€



A++
CLASE



Código	Modelo	P.Neto	Frig / h	SEER	SCOP	Int (mm)	Ext (mm)	Conex.	Long. Prec. (m)	Carg. Ad. (g/m)	L.V (m)	L.Mx (m)
ASY50UIKL	ASY 50 UI-KL	770 €	4472	A++	A+	293 x 790 x 249	542 x 799 x 290	1/4"-3/8"	15	20	20	25
ASY71UIKL	ASY 71 UI-KL	980 €	5418	A++	A+	293 x 790 x 249	632 x 799 x 290	1/4"-1/2"	15	20	25	30



ASYMI-LMC
MultiSplit - Unidades Interiores



A++
CLASE



Código	Modelo	P.Neto	Frig / h	Medidas (mm)	Conex.
ASY25MILMC	ASY 25 MI-LMC	230 €	2150	840 x 203 x 268	1/4"-3/8"
ASY35MILMC	ASY 35 MI-LMC	255 €	3010	840 x 203 x 268	1/4"-3/8"



AOYUI-MI
MultiSplit - Unidades Exteriores

R410A

Código	Modelo	P.Neto	Frig / h	SEER	SCOP	Medidas (mm)	Conex.	Long. Prec. (m)	Carg. Ad. (g/m)	L.V (m)	L.Mx (m)
AOY40UIMI2	AOY40UI-MI2 2 x 1	655 €	3440	A++	A+	790 x 290 x 540	2 x 1/4"-3/8"	20	10	15	30
AOY50UIMI2	AOY50UI-MI2 2 x 1	759 €	4300	A++	A+	790 x 290 x 540	2 x 1/4"-3/8"	20	20	15	30



ACU UiA-LL
Conductos -
Gama Comercial



P.Netto
212 €



Código	Modelo	P.Netto	Frig / h	SEER	SCOP	Int (mm)	Ext (mm)	Conex.	Long. Prec. (m)	Carg. Ad. (g/m)	L.V (m)	L.Mx (m)
ACY50UIALL	ACY 50 UIA-LL	885 €	4472	A++	A+	900 x 620 x 198	790 x 290 x 632	1/4"-1/2"	15	20	15	25



ACU UiA-LM
Conductos -
Gama Comercial



P.Netto
212 €



Código	Modelo	P.Netto	Frig / h	SEER	SCOP	Int (mm)	Ext (mm)	Conex.	Long. Prec. (m)	Carg. Ad. (g/m)	L.V (m)	L.Mx (m)
ACY71UIALM	ACY 71 UIA-LM	1.015 €	5848	A++	A+	1135 x 700 x 270	799 x 290 x 632	1/4"-5/8"	15	20	20	30
ACY80UIALM	ACY 80 UIA-LM	1.410 €	7310	A+	A	1135 x 700 x 270	900 x 330 x 830	3/8"-5/8"	20	40	30	50
ACY100UIALM	ACY 100 UIA-LM	1.470 €	8428	A+	A	1135 x 700 x 270	900 x 330 x 830	3/8"-5/8"	20	40	30	50
ACY125UIALM	ACY 125 UIA-LM	1.759 €	10406	A	A	1135 x 700 x 270	900 x 330 x 1290	3/8"-5/8"	20	40	30	75

Modelos Trifásicos

ACY100UIATLM	ACY 100 UIAT-LM	1.669 €	8600	A+	A+	1135 x 700 x 270	900 x 330 x 1290	3/8"-5/8"	30	50	30	75
ACY125UIATLM	ACY 125 UIAT-LM	2.005 €	10750	A	A	1135 x 700 x 270	900 x 330 x 1290	3/8"-5/8"	30	50	30	75



ACU UiA-LH
Conductos - Gama Comercial



P.Netto
212 €



Código	Modelo	P.Netto	Frig / h	SEER	SCOP	Int (mm)	Ext (mm)	Conex.	Long. Prec. (m)	Carg. Ad. (g/m)	L.V (m)	L.Mx (m)
ACY125UILH	ACY 125 UI-LH	2.155 €	10750	C	A	1050 x 500 x 400	900 x 330 x 1290	3/8"-5/8"	20	40	30	50
ACY140UILH	ACY 140 UI-LH	2.419 €	11524	C	B	1050 x 500 x 400	900 x 330 x 1290	3/8"-5/8"	20	40	30	50

Modelos Trifásicos

ACY125UIATLH	ACY 125H UIAT-LH	2.379 €	10750	B	A	1050 x 500 x 400	900 x 330 x 1290	3/8"-5/8"	30	50	30	75
ACY140UIATLH	ACY 140H UIAT-LH	2.500 €	12040	B	A	1050 x 500 x 400	900 x 330 x 1290	3/8"-5/8"	30	50	30	75
ACY170UIATLH	ACY 170H UIAT-LH	3.758 €	13760	B	A	1250 x 490 x 425	900 x 330 x 1290	3/8"-5/8"	30	50	30	75



AUY UiA-LV
Cassette -
Gama Comercial



P.Netto
212 €



Código	Modelo	P.Netto	Frig / h	SEER	SCOP	Int (mm)	Ext (mm)	Conex.	Long. Prec. (m)	Carg. Ad. (g/m)	L.V (m)	L.Mx (m)
AUY50UIALV	AUY 50 UIA-LV	1.030 €	4472	A++	A+	570 x 570 x 245	799 x 290 x 632	1/4"-1/2"	15	20	15	25
AUY71UIALV	AUY 71 UIA-LV	1.115 €	5848	A++	A+	570 x 570 x 245	799 x 290 x 632	1/4"-5/8"	15	20	20	30



AUU UiA-LR
Cassette -
Gama Comercial



P.Neto
212€



Código	Modelo	P.Neto	Frig / h	SEER	SCOP	Int (mm)	Ext (mm)	Conex.	Long. Prec. (m)	Carg. Ad. (g/m)	L.V (m)	L.Mx (m)
AUY80UIALR	AUY 80 UIA-LR	1.525 €	7310	A++	A+	840 x 840 x 288	900 x 330 x 830	3/8"-5/8"	20	40	30	50
AUY100UIALR	AUY 100 UIA-LR	1.615 €	8600	A++	A+	840 x 840 x 288	900 x 330 x 830	3/8"-5/8"	20	40	30	50
AUY125UIALR	AUY 125 UIA-LR	1.820 €	10750	A	A	840 x 840 x 288	900 x 330 x 1290	3/8"-5/8"	20	40	30	50
AUY140UIALR	AUY 140 UIA-LR	2.510 €	11438	B	A	840 x 840 x 288	900 x 330 x 1290	3/8"-5/8"	20	40	30	50

Modelos Trifásicos

AUY100UIATLR	AUY 100 UIAT-LR	1.830 €	8600	A++	A+	840 x 840 x 288	900 x 300 x 1290	3/8"-5/8"	30	50	30	75
AUY125UIATLR	AUY 125 UIAT-LR	2.169 €	10750	A	A	840 x 840 x 288	900 x 300 x 1290	3/8"-5/8"	30	50	30	75
AUY140UIATLR	AUY 140 UIAT-LR	2.549 €	12040	A	A	840 x 840 x 288	900 x 300 x 1290	3/8"-5/8"	30	50	30	75



ABY UiA-LV
Suelo-Techo -
Gama Comercial



P.Neto
212€



Código	Modelo	P.Neto	Frig / h	SEER	SCOP	Int (mm)	Ext (mm)	Conex.	Long. Prec. (m)	Carg. Ad. (g/m)	L.V (m)	L.Mx (m)
ABY50UIALV	ABY 50 UIA-LV	1.015 €	4472	A++	A+	990 x 655 x 199	799 x 290 x 632	1/4"-1/2"	20	40	15	20
ABY71UIALV	ABY 71 UIA-LV	1.199 €	5160	A+	A	990 x 655 x 199	799 x 290 x 632	1/4"-5/8"	20	40	15	20



ABY UiA-LR
Suelo-Techo -
Gama Comercial



P.Neto
212€



Código	Modelo	P.Neto	Frig / h	SEER	SCOP	Int (mm)	Ext (mm)	Conex.	Long. Prec. (m)	Carg. Ad. (g/m)	L.V (m)	L.Mx (m)
ABY80UIALR	ABY 80 UIA-LR	1.789 €	7310	A++	A+	1660 x 700 x 240	900 x 330 x 830	3/8"-5/8"	20	40	30	50
ABY100UIALR	ABY 100 UIA-LR	1.880 €	8084	A+	A+	1660 x 700 x 240	900 x 330 x 830	3/8"-5/8"	20	40	30	50
ABY125UIALR	ABY 125 UIA-LR	2.135 €	10750	A	A	1660 x 700 x 240	900 x 330 x 1290	3/8"-5/8"	20	40	30	50

Modelos Trifásicos

ABY100UIATLR	ABY 100 UIAT-LR	1.964 €	8600	A++	A+	1660 x 700 x 240	900 x 300 x 1290	3/8"-5/8"	30	50	30	75
ABY125UIATLR	ABY 125 UIAT-LR	2.235 €	10750	A	A	1660 x 700 x 240	900 x 300 x 1290	3/8"-5/8"	30	50	30	75
ABY140UIATLR	ABY 140 UIAT-LR	3.125 €	12040	B	B	1660 x 700 x 240	900 x 330 x 1290	3/8"-5/8"	30	50	30	75



AEROTERMIA



GMV5 HOME
Unidades Exteriores - Gama Industrial
Aeroterminia



Código	Modelo	P.Netto	Frig / h	SEER	SCOP	Medidas (mm)	Conex.	LV (m)	LMx (m)
GMV5H120	GMV5 H 120	1.975 €	10406	A++	A+	900 x 1345 x 340	3/8"-5/8"	50	150
GMV5H140	GMV5 H 140	2.035 €	12040	A++	A+	900 x 1345 x 340	3/8"-5/8"	50	150
GMV5H160	GMV5 H 160	2.065 €	13760	A++	A+	900 x 1345 x 340	3/8"-3/4"	50	150

Modelos Trifásicos

GMV5H224	GMV5 H 224	4.199 €	19264	A+++	A+++	1340 x 1605 x 765	3/8"-3/4"	50	150
GMV5H280	GMV5 H 280	4.450 €	24080	A++	A+++	1340 x 1605 x 765	3/8"-7/8"	50	150

SISTEMA GMV5 HOME CONECTADO AL HYDROBOX
Gama Industrial

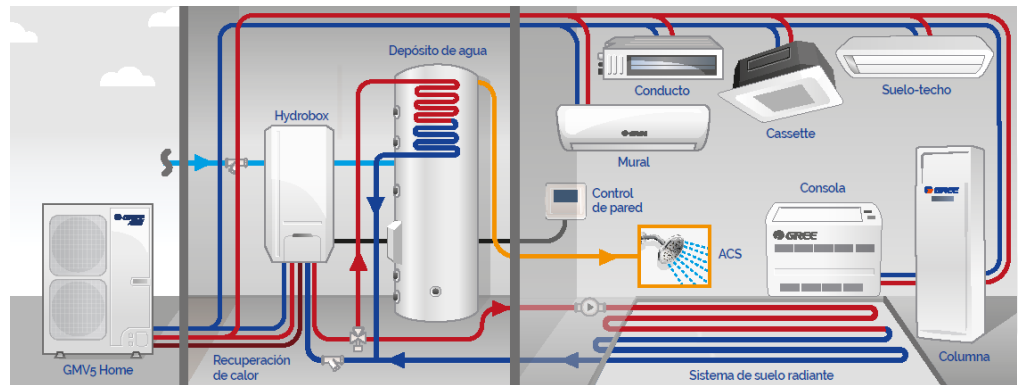

Código	Modelo	P.Netto	Potencia (Kw)	Caudal (m³/h)	Medidas (mm)	Conex.
GMV5HBOX16G	GMV5 HBOX 16G	1.595 €	16	1,7	500x919x328	1"

SISTEMA GMV5 HOME CONECTADO AL GENERADOR ACS
Gama Industrial

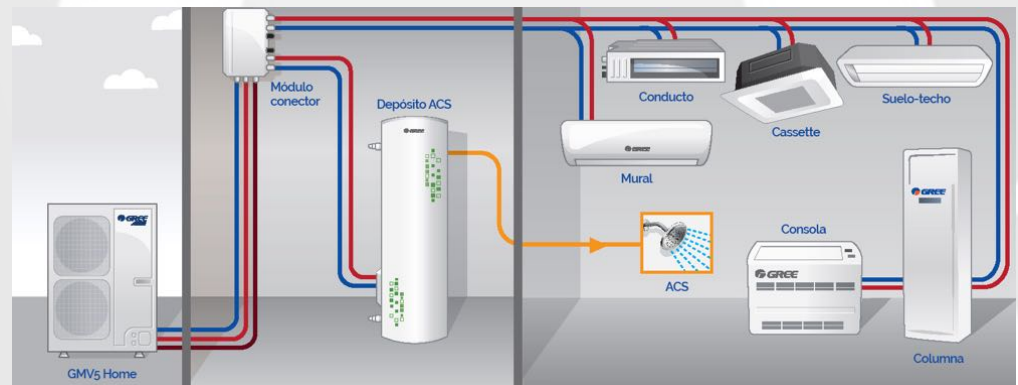

Código	Modelo	P.Netto	Potencia (Kw)	Capacidad (L)	Conexiones	Int (mm)	Ext (mm)
GENEACS	GENERADOR ACS	1.885 €	4,5	185	3/8" x 5/8" x 1/2" Alta presión	462 x 1944 x 462	370 x 485 x 135

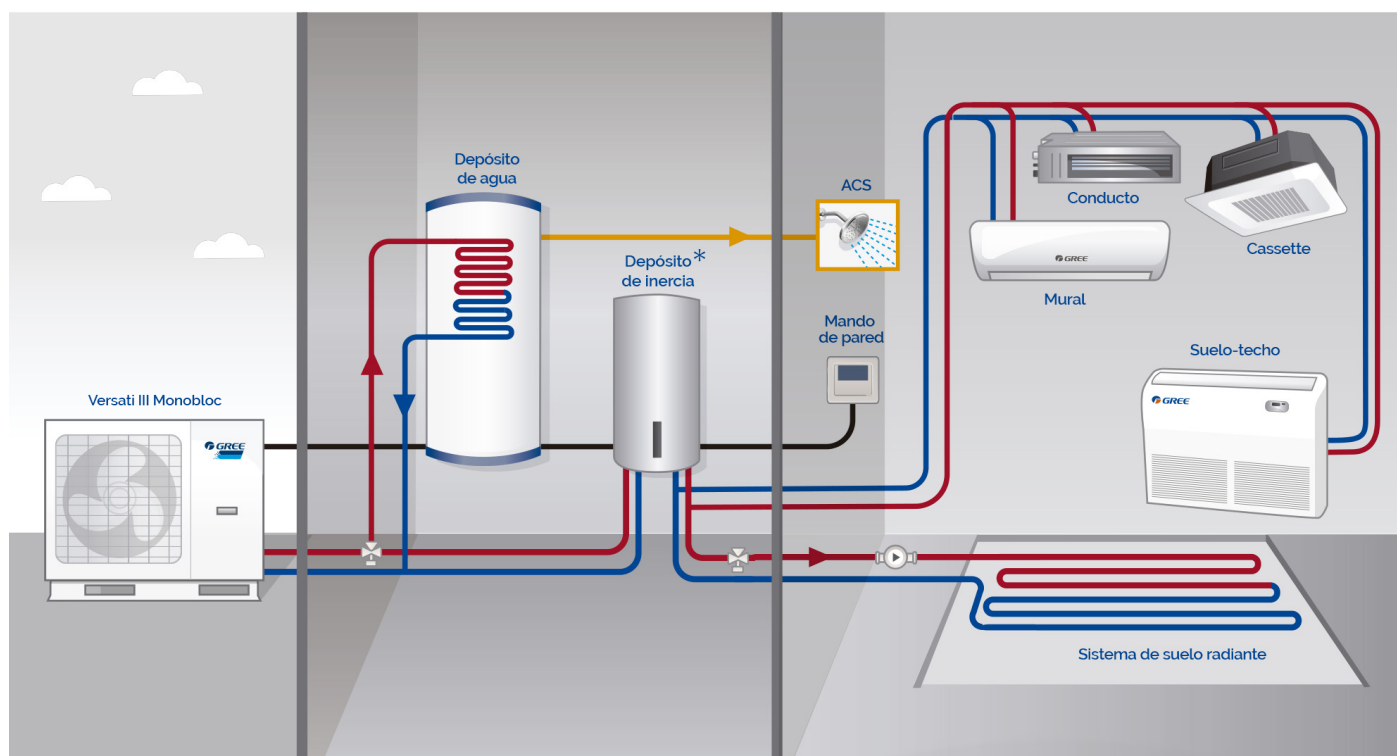

VERSATI III
Monobloc - Gama Industrial



Código	Modelo	P.Neto	Frig / h	SEER	SCOP	Medidas (mm)
VERSATIIIIIMB4	VERSATI III MB 4	2.005 €	2580	A++	A+	1150 x 756 x 390
VERSATIIIIIMB6	VERSATI III MB 6	2.050 €	3440	A++	A+	1150 x 756 x 390
VERSATIIIIIMB8	VERSATI III MB 8	2.215 €	4300	A++	A+	1150 x 756 x 390
VERSATIIIIIMB10	VERSATI III MB 10	2.645 €	6708	A++	A+	1200 x 878 x 460
VERSATIIIIIMB12	VERSATI III MB 12	3.310 €	8170	A++	A+	1200 x 878 x 460
VERSATIIIIIMB14	VERSATI III MB 14	3.429 €	10320	A++	A+	1200 x 878 x 460
VERSATIIIIIMB16	VERSATI III MB 16	3.565 €	11180	A++	A+	1200 x 878 x 460
Modelos Trifásicos						
VERSATIIIIIMB10-3F	VERSATI III MB 10-3F	2.910 €	6708	A++	A+	1200 x 878 x 460
VERSATIIIIIMB12-3F	VERSATI III MB 12-3F	3.310 €	8170	A++	A+	1200 x 878 x 460
VERSATIIIIIMB14-3F	VERSATI III MB 14-3F	3.429 €	10320	A++	A+	1200 x 878 x 460
VERSATIIIIIMB16-3F	VERSATI III MB 16-3F	3.600 €	11180	A++	A+	1200 x 878 x 460

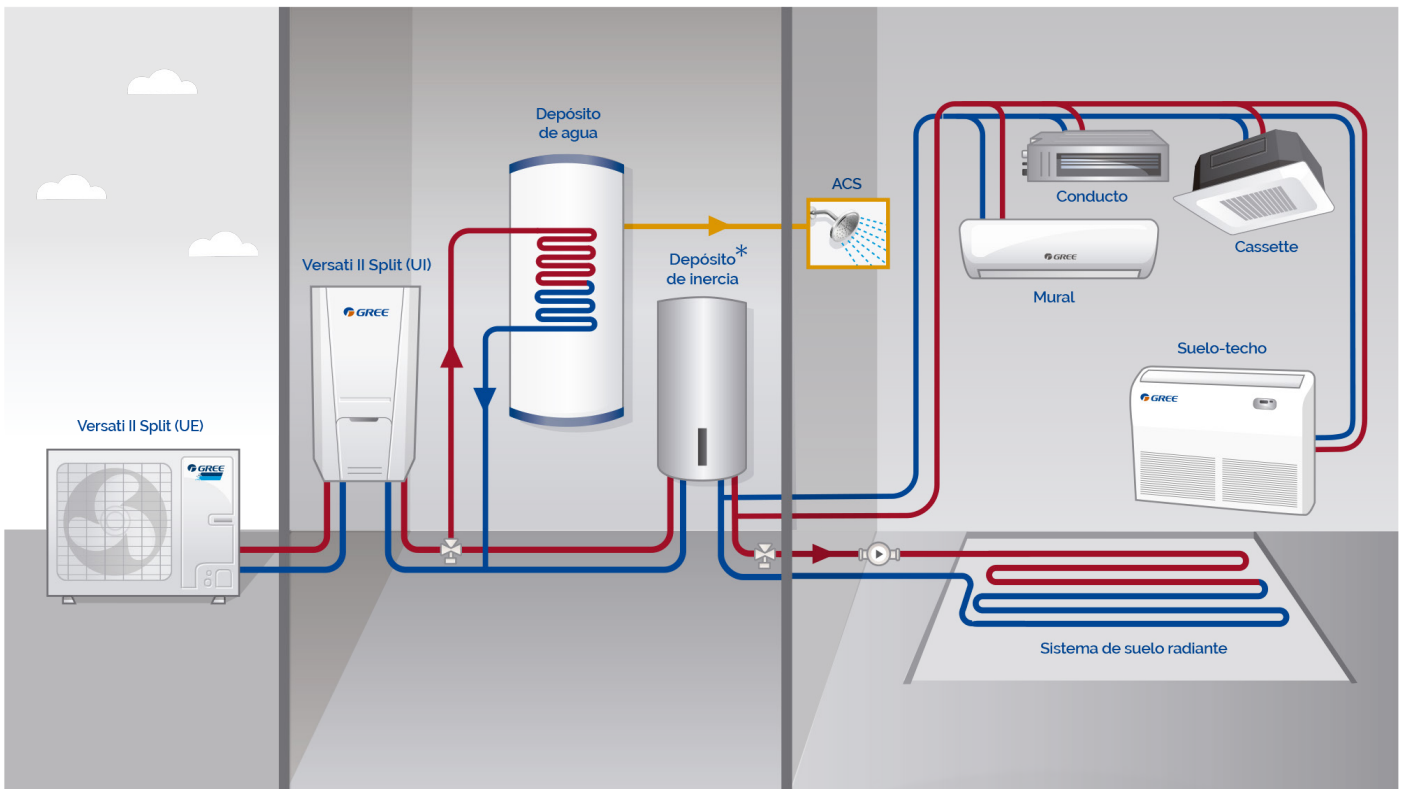

VERSATI III
Split - Gama Industrial



Código	Modelo	P.Net	Frig / h	SEER	SCOP	Int (mm)	Ext (mm)	Conex.	Long. Prec. (m)	Carg. Ad. (g/m)	L.V (m)	L.Mx (m)
VERSATIIIIISP4	VERSATI III SP 4	2.289 €	3354	A++	A	460x860x320	955x700x396	1/4"-1/2"	5	16	15	20
VERSATIIIIISP6	VERSATI III SP 6	2.349 €	4945	A++	A	460x860x320	955x700x396	1/4"-1/2"	5	16	15	20
VERSATIIIIISP8	VERSATI III SP 8	2.640 €	6020	A++	A	460x860x320	980x788x427	1/4"-1/2"	5	16	15	25
VERSATIIIIISP10	VERSATI III SP 10	2.820 €	7224	A++	A	460x860x320	980x788x427	1/4"-1/2"	5	16	15	25



VERSATI II
Split - Gama Industrial



Código	Modelo	P.Net	Frig / h	SEER	SCOP	Int (mm)	Ext (mm)	Conex.	Long. Prec. (m)	Carg. Ad. (g/m)	L.V (m)	L.Mx (m)
VERSATIISP12	VERSATI II SP 12	3.020 €	7310	A++	A+	500x918x324	900x1345x412	3/8"-5/8"	10	50	15	30
VERSATIISP14	VERSATI II SP 14	3.059 €	7740	A++	A+	500x918x324	900x1345x412	3/8"-5/8"	10	50	15	30
VERSATIISP16	VERSATI II SP 16	3.099 €	8342	A++	A+	500x918x324	900x1345x412	3/8"-5/8"	10	50	15	30

Modelos Trifásicos

VERSATIISP12-3F	VERSATI II SP 12-3F	3.195 €	8600	A++	A+	500x918x324	900x1345x412	3/8"-5/8"	10	50	15	30
VERSATIISP14-3F	VERSATI II SP 14-3F	3.255 €	9030	A++	A+	500x918x324	900x1345x412	3/8"-5/8"	10	50	15	30
VERSATIISP16-3F	VERSATI II SP 16-3F	3.310 €	9460	A++	A+	500x918x324	900x1345x412	3/8"-5/8"	10	50	15	30



AQUAL
Depósito de agua - Aerothermia



Código	Modelo	P.Neto	Clase Energética		Cap. Depósito (L)	Medidas (mm)
31GR0081	AQUAL	965 €	A++	A+	300	620 x 1722 x 620



OMEGA
Bomba de calor ACS monobloc - Aerothermia



Incluido



9AGR1288



Código	Modelo	P.Neto	Clase Energética	Cap. Depósito (L)	Medidas (mm)
31GR5200	OMEGA 270	1.015 €	A	270	660 x 1958 x 667



AEROS
Bomba de calor ACS monobloc - Aerothermia



Código	Modelo	P.Neto	Clase Energética	Cap. Depósito (L)	Medidas (mm)
31GR5199	AEROS MB 190	1.115 €	A	190	591 x 1685 x 591



MARINA
Bomba de calor ACS Split - Aerothermia



Incluido



9AGR1288



Código	Modelo	P.Neto	Clase Energética	Cap. Depósito (L)	Int. (mm)	Ext. (mm)
31GR5210	MARINA SP 185	1.235 €	A+	185	462 x 1944 x 462	842 x 591 x 320



ACCESORIOS AEROTHERMIA

Código	Modelo	P.Neto	Sistema de control	Bombas de calor VERSATI			Bombas de calor ACS		
				III Monob.	III Split	II Split	Omega	Aeros	Marina
9AGR5036	300001060261	187 €	Control integrado	●	●				
9AGR2366	30292000047	59 €	Control integrado			●			
9AGR1288	30296000028	60 €	Control por cable				●	●	●

Gama **ecodan**
Esquemas de instalación Split reversible R32 dos zonas

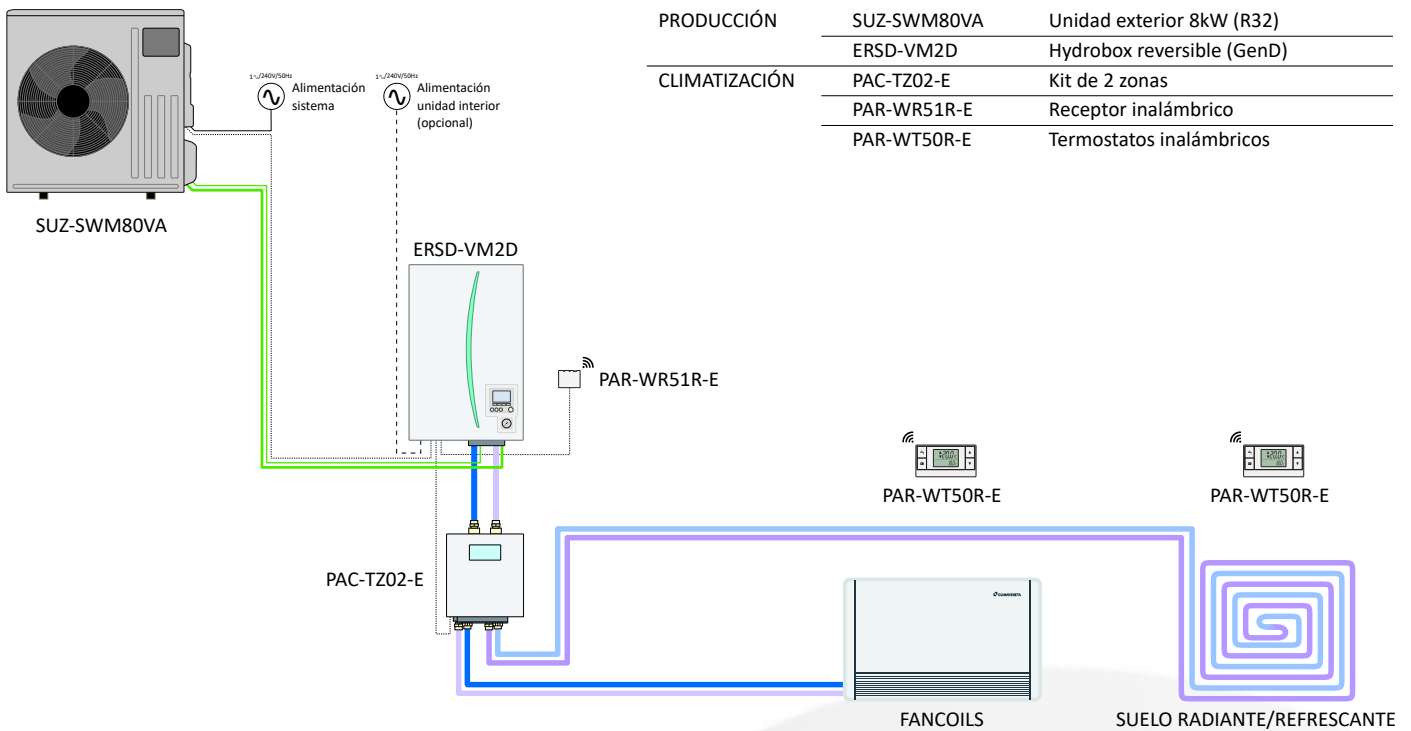

PRODUCCIÓN	SUZ-SWM80VA	Unidad exterior 8kW (R32)
	ERSD-VM2D	Hydrobox reversible (GenD)
CLIMATIZACIÓN	PAC-TZ02-E	Kit de 2 zonas
	PAR-WR51R-E	Receptor inalámbrico
	PAR-WT50R-E	Termostatos inalámbricos

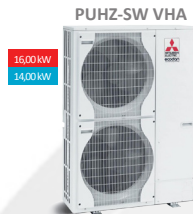

SISTEMAS DE 4 A 16 KW
Gama ecodan - Unidades Exteriores



Código	Modelo	P.Netto	Frig / h	Medidas (mm)	Conex.	Long. Precarga (m)	L.Mx (m)
SUZSWM40VA	SUZ-SWM40VA	1.025 €	4816	880 x 840 x 330	1/4"-1/2"	10	30
SUZSWM60VA	SUZ-SWM60VA	1.150 €	5160	880 x 840 x 330	1/4"-1/2"	10	30
SUZSWM80VA	SUZ-SWM80VA	1.460 €	5418	880 x 840 x 330	1/4"-1/2"	10	30
PUHZSW75VAA	PUHZ-SW75VAA	1.635 €	6106	1020 x 1050 x 480	3/8"-5/8"	10	40
PUHZSW100VAA	PUHZ-SW100VAA	2.025 €	8600	1020 x 1050 x 480	3/8"-5/8"	10	75
PUHZSW120VHA	PUHZ-SW120VHA	2.745 €	12040	1350 x 950 x 330	3/8"-5/8"	10	75



SISTEMAS SPLIT DE 4 A 8 KW
Gama ecodan - Unidades Interiores



Código	Modelo	P.Netto	Medidas (mm)	Capacidad (L)	Conex.
ERSDVM2D	ERSD-VM2D	1.455 €	800 x 530 x 360	-	1/4"-1/2"
ERST17DVM2D	ERST17D-VM2D	1.389 €	1400 x 595 x 680	170	1/4"-1/2"
ERST20DVM2D	ERST20D-VM2D	2.435 €	1600 x 595 x 680	200	1/4"-1/2"
ERST30DVM2ED	ERST30D-VM2ED	2.559 €	2050 x 595 x 680	300	1/4"-1/2"
ERST20CVM2D	ERST20C-VM2D	2.765 €	1600 x 595 x 680	200	1/4"-3/8"
ERST30CVM2ED	ERST30C-VM2ED	2.900 €	2050 x 595 x 680	300	1/4"-3/8"

Gama **ecodan**
Esquemas de instalación **Ecodan Híbrido con CITY MULTI**

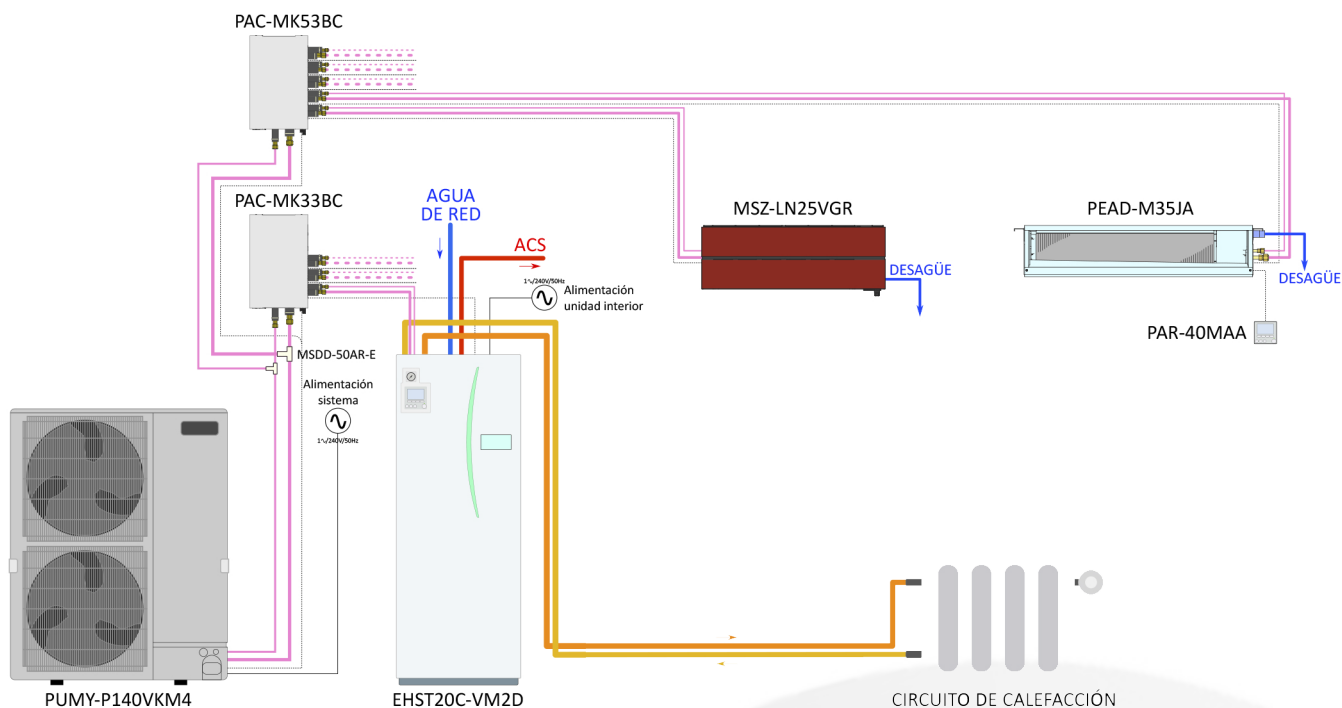

ECODAN HÍBRIDO CON CITY MULTI
Gama ecodan - Unidades Exteriores



Código	Modelo	P.Netto	Frig / h	Medidas (mm)	Conex.	L.V (m)	L.Mx (m)
PUMYP112VKM4	PUMY-P112VKM4	3.360 €	10750	1338 x 1050 x 330	3/8"-5/8"	50	80
PUMYP125VKM4	PUMY-P125VKM4	3.575 €	12040	1338 x 1050 x 330	3/8"-5/8"	50	80
PUMYP140VKM4	PUMY-P140VKM4	4.075 €	13330	1338 x 1050 x 330	3/8"-5/8"	50	80



ECODAN HÍBRIDO CON CITY MULTI
Gama ecodan - Unidades Interiores ATW



Código	Modelo	P.Netto	Medidas (mm)	Capacidad (L)	Conex.
EHST20CVM2D	EHST20C-VM2D	2.585 €	1600 x 595 x 680	200	3/8"-5/8"
EHSCVM2D	EHSC-VM2D	1.565 €	800 x 530 x 360	-	3/8"-5/8"

LG Therma V Split con Hidrokit Mural: THERMA V™

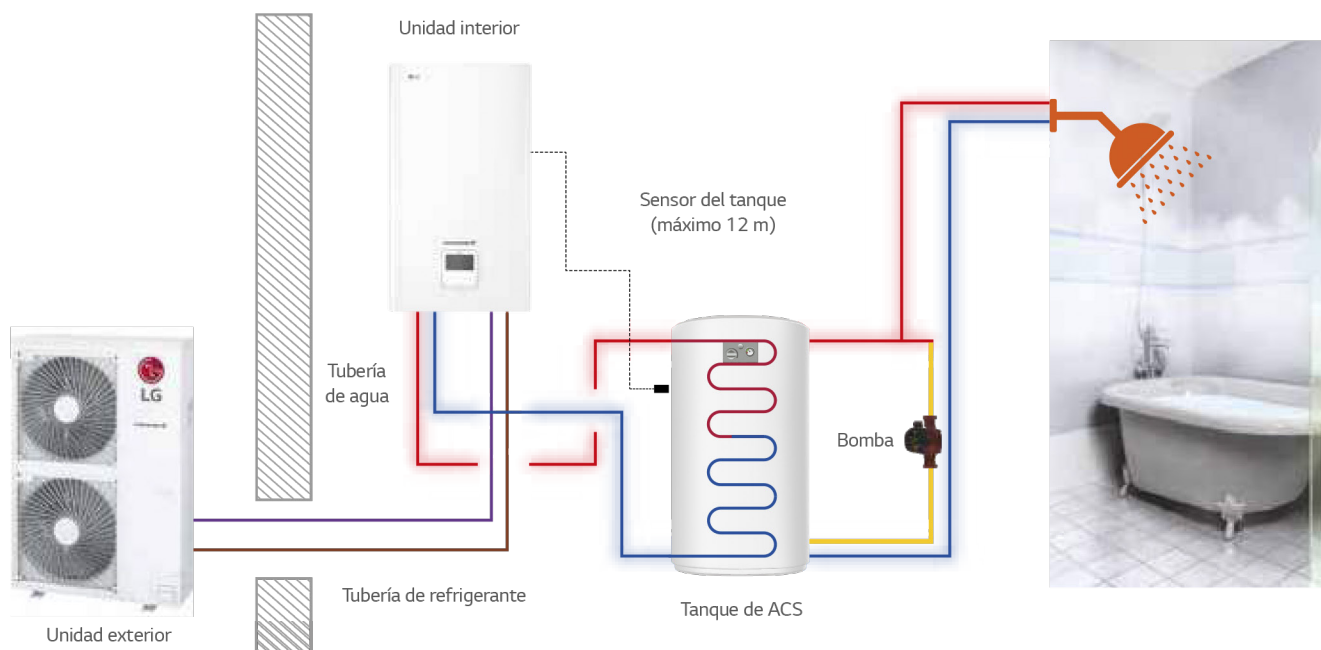

THERMA V SPLIT HIDROKIT MURAL R32
Gama Therma V



Código	Ud. exterior	P.Neto	Medidas (mm)	Unidad interior	Medidas (mm)	Bandeja de condensados
SETTHERMASP5R32	HU051MR.U44	2.680 €	950 x 834 x 330	HN0916M.NK4	490 x 850 x 315	PHDPB
SETTHERMASP7R32	HU071MR.U44	2.699 €	950 x 834 x 330	HN0916M.NK4	490 x 850 x 315	PHDPB
SETTHERMASP9R32	HU091MR.U44	2.720 €	950 x 834 x 330	HN0916M.NK4	490 x 850 x 315	PHDPB



THERMA V SPLIT HIDROKIT MURAL
Gama Therma V



Medidas (mm)	Ud. exterior	P.Neto	Medidas (mm)	Unidad interior	Medidas (mm)	Bandeja de condensados
SETTHERMASP5	HU051.U43	2.445 €	950 x 834 x 330	HN1616.NK3	490 x 850 x 315	PHDPB
SETTHERMASP7	HU071.U43	2.450 €	950 x 834 x 330	HN1616.NK3	490 x 850 x 315	PHDPB
SETTHERMASP9	HU091.U43	2.469 €	950 x 834 x 330	HN1616.NK3	490 x 850 x 315	PHDPB
SETTHERMASP12	HU121.U33	2.790 €	950 x 1380 x 330	HN1616.NK3	490 x 850 x 315	PHDPB
SETTHERMASP14	HU141.U33	3.065 €	950 x 1380 x 330	HN1616.NK3	490 x 850 x 315	PHDPB
SETTHERMASP16	HU161.U33	3.415 €	950 x 1380 x 330	HN1616.NK3	490 x 850 x 315	PHDPB

Modelos Trifásicos

SETTHERMASP12T	HU123.U33	2.870 €	950 x 1380 x 330	HN1639.NK3	490 x 850 x 315	PHDPB
SETTHERMASP14T	HU143.U33	3.025 €	950 x 1380 x 330	HN1639.NK3	490 x 850 x 315	PHDPB
SETTHERMASP16T	HU163.U33	3.370 €	950 x 1380 x 330	HN1639.NK3	490 x 850 x 315	PHDPB



ACCESORIOS THERMA V

PHLTA	PHLTA	114 €	Kit LG para depósito ACS			
PHDPB	PHDPB	152 €	Bandeja de condensados para los hidrokits murales. Obligatorio en caso de trabajar en frío.			

LG Therma V R32 Monobloc: **THERMA V™**

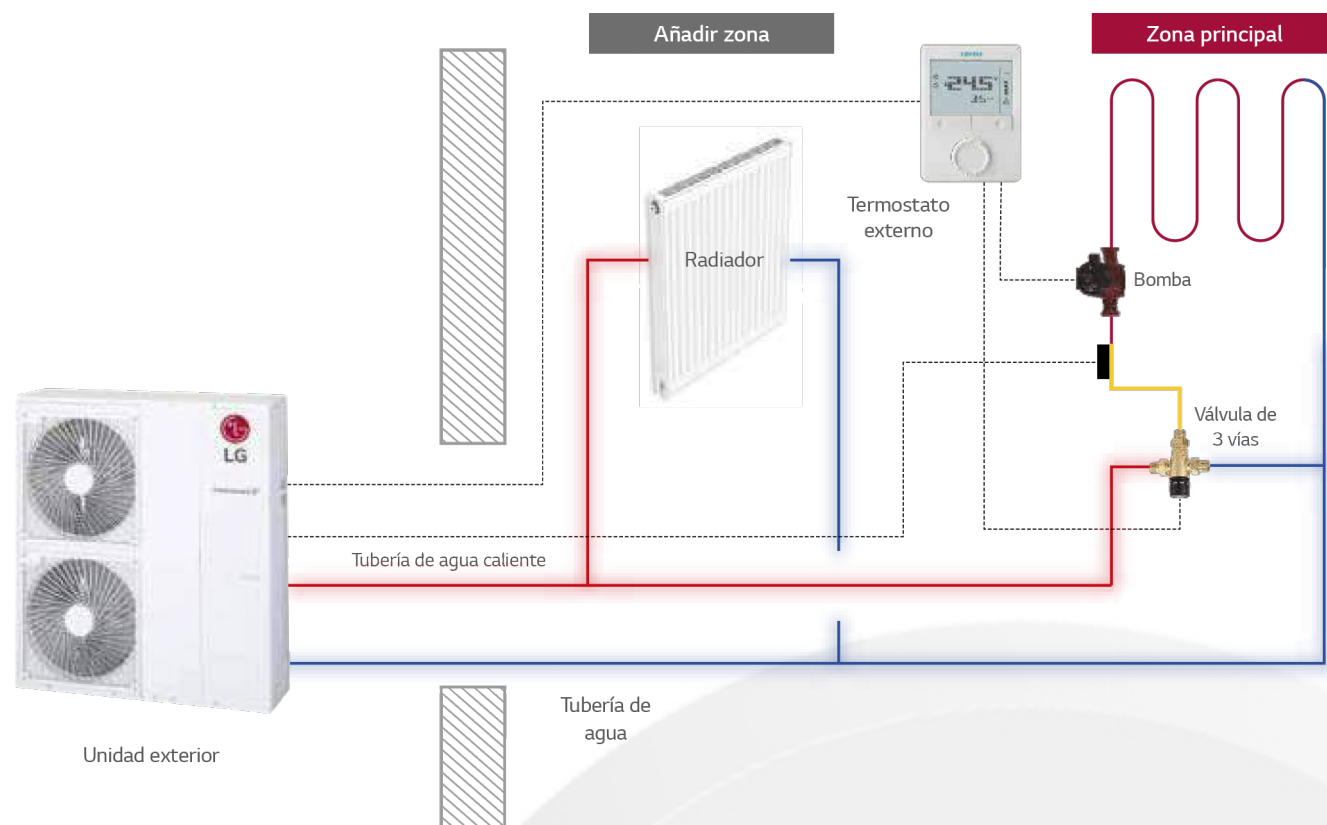

THERMA V MONOBLOC R32
Gama Therma V



Código	Modelo	P.Netto	Frig / h	SEER	SCOP	Medidas (mm)
HM051MU43	HM051M.U43	2.379 €	4730	A+++	A++	1.239 x 834 x 330
HM071MU43	HM071M.U43	2.460 €	6020	A+++	A++	1.239 x 834 x 330
HM091MU43	HM091M.U43	2.489 €	7740	A+++	A++	1.239 x 834 x 330
HM121MU33	HM121M.U33	3.165 €	10320	A+++	A++	1.239 x 1.380 x 330
HM141MU33	HM141M.U33	3.490 €	12040	A+++	A++	1.239 x 1.380 x 330
HM161MU33	HM161M.U33	3.935 €	13760	A+++	A++	1.239 x 1.380 x 330
Modelos Trifásicos						
HM123MU43T	HM123M.U43	3.285 €	10320	A+++	A++	1.239 x 1.380 x 330
HM143MU33T	HM143M.U33	3.760 €	12040	A+++	A++	1.239 x 1.380 x 330
HM163MU33T	HM163M.U33	4.180 €	13760	A+++	A++	1.239 x 1.380 x 330

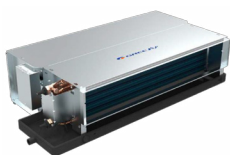

CONDUCTOS BATERÍA 2 TUBOS

Fancoil - Unidades Interiores

*Plenum con filtro incluido

Código	Modelo	P.Netto	Frig / h	Medidas (mm)	Conex.
3IGR7063	FANCOIL CDT 20	96 €	1720	680x235x500	3/4" - 3/4"
3IGR7064	FANCOIL CDT 31	110 €	2666	800x235x500	3/4" - 3/4"
3IGR7072	FANCOIL CDT 33	120 €	2838	800x235x500	3/4" - 3/4"
3IGR7073	FANCOIL CDT 42	137 €	3612	900x235x500	3/4" - 3/4"
3IGR7067	FANCOIL CDT 54	147 €	4644	1080x235x500	3/4" - 3/4"
3IGR7075	FANCOIL CDT 62	160 €	5332	1080x235x500	3/4" - 3/4"
3IGR70608	FANCOIL CDT 69	206 €	5934	1380x235x500	3/4" - 3/4"
3IGR7076	FANCOIL CDT 78	221 €	6708	1380x235x500	3/4" - 3/4"
3IGR7069	FANCOIL CDT 86	230 €	7396	1520x235x500	3/4" - 3/4"
3IGR7070	FANCOIL CDT 102	245 €	8772	1620x235x500	3/4" - 3/4"
3IGR7078	FANCOIL CDT 105	240 €	9030	1620x235x500	3/4" - 3/4"



CASSETTE 2 TUBOS

Fancoil - Unidades Interiores

Código	Modelo	P.Netto	Frig / h	Medidas (mm)	Conex.
3IGR7115K	FANCOIL CST 2C30V4	245 €	2580	600x230x600	3/4" - 1"
3IGR7116K	FANCOIL CST 2C35V4	265 €	3010	600x230x600	3/4" - 1"
3IGR7106K	FANCOIL CST 2C45V4	290 €	3870	840x190x840	3/4" - 1"
3IGR7107K	FANCOIL CST 2C50V4	299 €	4300	840x190x840	3/4" - 1"
3IGR7108K	FANCOIL CST 2C60V4	315 €	5160	840x240x840	3/4" - 1"

● Opcional

● De serie

SISTEMAS DE CONTROL FANCOILS

Código	Modelo	P.Netto	Sistema de control	Conductos	Cassette
3IGR9136	DQ34	161 €	Electronica + control	●	
3IGR9126	Z4E351B	25 €	Control por cable		●
3IGR9130	WK-010PA-K	108 €	Termostato digital	●	
3IGR9131	WK-110PA0	39 €	Termostato digital	●	
3IGR9137	DQ34 + YB1FA	179 €	Control inalámbrico	●	●
3IGR9017	YB1FA	39 €	Control inalámbrico		●
3IGR9127	ME30-17/E2(M)	137 €	Interfaz Modbus	●	●
3IGR9122	RS485-W	290 €	Multiplexor de señal	●	●
3IGR9123	GD02	231 €	Convertidor optoelectrónico		

Kit de válvulas	FANCOIL V 2V 1/2	FANCOIL V 2V 3/4	FANCOIL V 2V 1	FANCOIL V 3V 1/2	FANCOIL V 3V 3/4	FANCOIL V 3V 1
Código	3IGR9600	3IGR9601	3IGR9602	3IGR9603	3IGR9604	3IGR9605
P. Netto	66 €	70 €	74 €	103 €	108 €	118 €

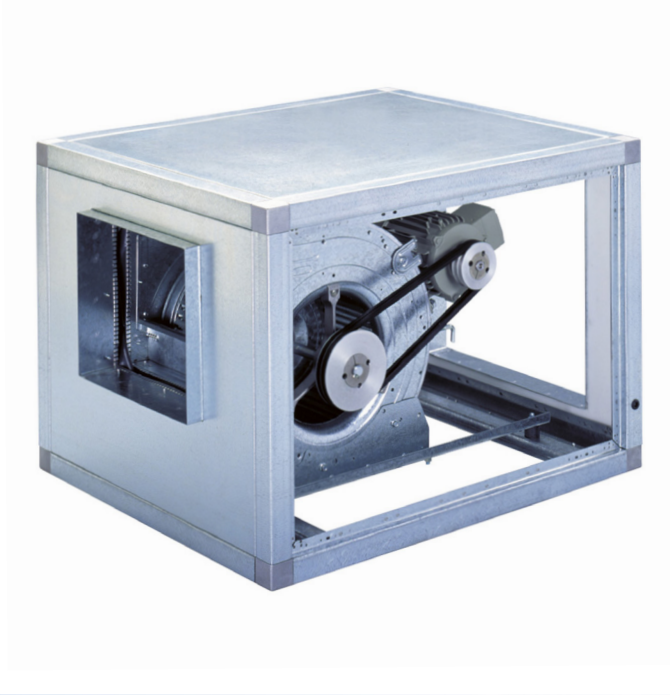

VENTILACIÓN



RECUPERADORES DE CALOR ARR CC
Recuperadores estáticos contraflujo



Código	Modelo	P.V.P	Caudal nominal m³/h	Rendimiento nominal %	Medidas L x A x Al (mm)
ARRCC10	ARR CC 10	2.359,00 €	800	86,46	1505 x 870 x 372
ARRCC15	ARR CC 15	2.618,00 €	1500	84,46	1885 x 1015 x 454
ARRCC20	ARR CC 20	3.686,00 €	2000	84,09	1885 x 1225 x 454
ARRCC30	ARR CC 30	4.144,00 €	3000	83,85	2100 x 1240 x 593
ARRCC40	ARR CC 40	5.238,00 €	4000	86,06	1885 x 1225 x 848
ARRCC60	ARR CC 60	6.272,00 €	6000	85,58	2000 x 1240 x 1126

* Incluye presostatos y control element.

FILTROS Y ACCESORIOS

Modelo	Filtro G4	Filtro F5	Filtro F6	Filtro F7	Filtro F8	Filtro F9	Mando Sup.	Control CO2
ARR CC 10 H	7,00 €	7,00 €	28,10 €	28,90 €	29,80 €	30,70 €	106,00 €	500,00 €
ARR CC 15 H	7,00 €	7,00 €	31,30 €	32,30 €	33,20 €	34,20 €	106,00 €	500,00 €
ARR CC 20 H	11,50 €	11,50 €	36,20 €	37,30 €	38,50 €	39,60 €	106,00 €	500,00 €
ARR CC 30 H	11,50 €	11,50 €	42,30 €	43,60 €	44,90 €	46,20 €	106,00 €	500,00 €
ARR CC 40 H	16,60 €	16,60 €	79,80 €	82,20 €	84,70 €	87,20 €	106,00 €	523,00 €
ARR CC 50 H	32,00 €	32,00 €	105,70 €	108,90 €	112,10 €	115,50 €	106,00 €	531,00 €



BOX BD
Cajas de ventilación - Centrífugo en caja insonorizada



Código	Modelo	P.V.P.	R.P.M.	I nom. (A) 230V	I nom. (A) 400V	P. Nom. kW	Q máx. m3/h	Sonido dB (A)	Peso Kg
251100551	BOX BD 7/7 M4 0,13kW	331,00 €	1370	1,55	-	0,13	1850	56	19
251220550	BOX BD 9/9 M4 0,35kW	377,00 €	1375	2,7	-	0,35	2670	58	30
251320550	BOX BD 10/10 M4 0,59kW	410,00 €	1340	4,50	-	0,59	3790	61	34
251160550	BOX BD 7/7 M6 0,04kW	312,00 €	885	0,6	-	0,04	1020	41	20
251280550	BOX BD 9/9 M6 0,12kW	368,00 €	925	1,2	-	0,12	2030	50	28
251370550	BOX BD 10/10 M6 0,19kW	400,00 €	880	2,1	-	0,19	2870	56	32
251520550	BOX BD 12/12 M6 0,79kW	547,00 €	945	6,2	-	0,79	6170	63	49

Modelos Trifásicos

251520153	BOX BD 12/12 T6 1,1kW	561,00 €	945	6,54	3,78	1,1	6090	56	51
252370157	BOX BD 15/15 T6 2,2kW	905,00 €	900	10,92	6,31	2,2	10450	61	71



REG
Regulador de velocidad manual monofásico

Código	Modelo	P.V.P.	I máx. (A)	Tensión (V)	Peso Kg
251100261	REG 1.5A	93,00 €	1,5	230	0,35
251160260	REG 3A	100,00 €	3	230	0,42
251270260	REG 5A	119,00 €	5	230	0,57
251260261	REG 10A	209,00 €	10	230	0,76



KUVIO
Helicentrífugo, construido en resina plástica



Código	Modelo	P.V.P.	R.P.M	I nominal (A) 230 V	Potencia kW	Q. max m3/h	Sonido dB (A)	Peso kg
KUV100	KUVIO 100	64,00 €	2180/2385	0,11/0,21	0,021/0,033	190	27	1,4
KUV100	KUVIO 150	102,00 €	1680/2460	0,17/0,27	0,03 / 0,06	520	43	3
KUV200V0	KUVIO 200 V0	157,00 €	1915/2380	0,34/0,48	0,076 / 0,108	1040	49	6,4
KUV250V0	KUVIO 250 V0	248,00 €	1955/2440	0,54/0,79	0,125/0,177	1400	47	8,3
KUV315V0	KUVIO 315 V0	327,00 €	1890/2335	1/1,42	0,23/0,32	2050	48	11,4



LÍDERO
Helicoidal de extracción con compuerta antirretorno



Código	Modelo	P.V.P.	R.P.M Nominal	I nominal (A) 230 V	Potencia W	Q. max m3/h	Sonido dB (A)	Peso kg
LID100	LÍDERO 100	23,00 €	2300	0,10	18	90	37	0,60
LID125	LÍDERO 125	29,00 €	2100	0,12	20	175	39	0,80
LID150	LÍDERO 150	37,00 €	2100	0,15	30	335	46	1,10



VENTILWEST M-1
Tubos superflexibles

Código	Ø Int	P.Net
607004083	80	8,42 €
607000183	102	4,42 €
607000283	127	5,40 €
607000383	152	5,98 €
607002583	160	6,24 €
607002683	180	7,94 €
607000483	203	8,04 €
607002783	229	9,95 €
607000583	254	10,42 €
607000683	305	13,35 €
607002883	315	14,10 €
607000783	356	16,58 €
607000883	406	20,61 €
607002983	457	28,38 €



CALOWEST M-1
Tubos superflexibles

Código	Ø Int	P.Net
607004183	80	19,92 €
607001783	102	14,95 €
607001883	127	16,78 €
607001983	152	18,35 €
607003083	160	18,77 €
607003183	180	24,47 €
607002083	203	24,52 €
607003283	229	30,65 €
607002183	254	29,63 €
607002283	305	39,16 €
607003383	315	40,98 €
607002383	356	48,28 €
607002483	406	59,52 €
607003483	457	70,91 €



VENTILWEST COMBI
PVC / ALU
Tubos superflexibles

Código	Ø Int	P.Net
607000983	102	10,68 €
607001083	127	11,60 €
607001183	152	13,24 €
607003583	160	14,35 €
607003683	180	16,37 €
607001283	203	18,24 €
607003783	229	20,14 €
607001383	254	22,70 €
607001483	305	26,79 €
607003883	315	27,13 €
607001583	356	31,99 €
607001683	406	37,35 €
607003983	457	46,78 €

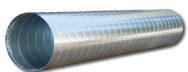

TUBO 3m WESTERFIX
Cond. helicoidal galva.

Código	Espesor	Ø mm	P.Net
607004283		100	6,85 €
607004383		125	8,57 €
607004483		150	10,25 €
607004583	0,5 mm	200	13,61 €
607004683		250	17,85 €
607004783		300	21,40 €
607004883		315	24,06 €
607004983		355	31,50 €
607005083	0,6 mm	400	37,13 €
607005183		450	41,76 €
607005283		500	46,44 €
607005383		560	60,53 €
607005483	0,7 mm	600	64,76 €
607005583		630	67,93 €
607005683		710	111,84 €
607005783	1 mm	750	118,16 €
607005883		800	126,02 €



Manguito
Accesorios

Ø mm	P.Net
100	0,79 €
125	0,91 €
150	1,08 €
200	1,32 €
250	1,63 €
300	1,97 €
315	2,15 €
355	2,34 €
400	2,62 €
450	3,19 €
500	3,56 €
560	3,84 €
600	4,07 €
630	4,72 €
710	5,89 €
750	- €
800	6,59 €



Codo 45º
Accesorios

P.Net
2,26 €
2,55 €
3,26 €
5,27 €
5,91 €
7,98 €
10,52 €
10,82 €
12,97 €
16,65 €
19,07 €
23,03 €
26,18 €
28,05 €
33,35 €
- €
40,93 €



Codo 90º
Accesorios

P.Net
2,53 €
3,86 €
5,65 €
7,52 €
9,04 €
12,56 €
16,08 €
16,60 €
20,34 €
26,97 €
30,24 €
36,04 €
45,01 €
48,83 €
52,42 €
- €
64,53 €



Pico flauta con maya
Accesorios

P.Net
7,84 €
9,03 €
10,03 €
11,66 €
13,44 €
16,77 €
16,97 €
18,74 €
21,62 €
24,61 €
28,00 €
35,94 €
39,33 €
42,41 €
51,10 €
- €
- €



Te 45°
Accesorios

Ø mm	P.Net
100	7,29 €
125	9,00 €
150	10,26 €
200	14,10 €
250	17,69 €
300	22,30 €
315	25,53 €
355	28,80 €
400	29,67 €
450	44,06 €
500	51,53 €
560	61,24 €
600	68,12 €
630	73,54 €
710	100,06 €
750	-
800	123,19 €



Te 90°
Accesorios

P.Net
3,20 €
5,57 €
7,29 €
9,57 €
12,62 €
16,47 €
18,38 €
21,07 €
25,40 €
29,98 €
34,88 €
41,20 €
45,68 €
51,73 €
69,68 €
-
87,56 €



Caperuzas
Accesorios

P.Net
5,02 €
5,80 €
6,48 €
8,64 €
10,36 €
13,04 €
14,39 €
15,49 €
17,64 €
21,07 €
24,89 €
26,90 €
30,70 €
33,45 €
43,43 €
-
50,79 €



C. Antirrev.
Accesorios

P.Net
6,96 €
7,85 €
8,89 €
10,90 €
13,13 €
15,44 €
16,65 €
18,25 €
20,52 €
23,14 €
26,44 €
30,23 €
33,59 €
36,95 €
45,80 €
-
53,71 €



C. Extract.
Accesorios

P.Net
19,89 €
20,37 €
21,16 €
24,60 €
26,16 €
29,06 €
-
38,41 €
45,97 €
60,60 €
92,90 €
-
-
-
-
-



Caperuza. Jet
Accesorios

P.Net
-
-
46,98 €
61,92 €
81,76 €
86,02 €
97,97 €
105,63 €
117,30 €
137,94 €
153,00 €
180,48 €
193,89 €
216,90 €
250,65 €
-
321,75 €



Reducciones
Accesorios

Ø mm	100	150	200	250	300	315	355
125	2,71 €	-	-	-	-	-	-
150	3,14 €	-	-	-	-	-	-
160	3,11 €	3,52 €	-	-	-	-	-
200	4,01 €	4,28 €	-	-	-	-	-
250	9,09 €	6,12 €	5,21 €	-	-	-	-
300	11,29 €	11,05 €	10,56 €	10,32 €	-	-	-
355	14,04 €	11,73 €	13,02 €	12,63 €	12,12 €	11,93 €	-
400	16,53 €	16,02 €	15,27 €	14,76 €	14,14 €	13,91 €	13,31 €
450	19,56 €	18,93 €	18,04 €	17,40 €	16,65 €	16,38 €	15,67 €
500	22,91 €	22,13 €	21,11 €	20,33 €	19,44 €	19,13 €	18,31 €
560	23,29 €	26,35 €	25,16 €	24,22 €	23,16 €	22,80 €	21,85 €
600	30,44 €	29,40 €	28,10 €	27,04 €	25,87 €	25,48 €	24,43 €
630	38,40 €	36,86 €	35,06 €	33,52 €	31,86 €	31,32 €	29,89 €
710	44,14 €	45,27 €	43,20 €	41,38 €	39,42 €	38,80 €	37,15 €
800	58,07 €	55,92 €	53,52 €	51,37 €	49,09 €	48,37 €	46,45 €



P.Netto
2,37 €
2,54 €
2,80 €
3,26 €
4,12 €
5,14 €
5,45 €
6,35 €
7,37 €
8,53 €
9,58 €
11,12 €
12,21 €
13,01 €
17,44 €
-
20,70 €



P.Netto
1,26 €
1,39 €
1,51 €
1,77 €
2,51 €
3,04 €
3,54 €
4,11 €
4,31 €
4,65 €
4,99 €
5,40 €
5,97 €
6,17 €
6,72 €
-
7,52 €



P.Netto
2,08 €
2,36 €
2,64 €
2,92 €
4,84 €
5,52 €
5,72 €
6,27 €
6,89 €
7,58 €
8,27 €
9,10 €
9,66 €
10,09 €
11,21 €
-
12,45 €



P.Netto
-
-
-
-
-
10,69 €
11,20 €
12,48 €
13,97 €
16,63 €
18,30 €
20,28 €
23,17 €
24,20 €
26,80 €
-
29,83 €

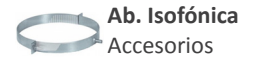

P.Netto
0,97 €
1,12 €
1,33 €
1,72 €
2,03 €
2,32 €
2,46 €
2,71 €
3,25 €
5,76 €
6,58 €
7,18 €
7,57 €
7,86 €
8,65 €
-
9,53 €

	400	450	500	560	600	630	710
-	-	-	-	-	-	-	-
-	-	-	-	-	-	-	-
-	-	-	-	-	-	-	-
-	-	-	-	-	-	-	-
-	-	-	-	-	-	-	-
-	-	-	-	-	-	-	-
-	-	-	-	-	-	-	-
-	-	-	-	-	-	-	-
15,00 €	-	-	-	-	-	-	-
17,51 €	16,61 €	-	-	-	-	-	-
20,89 €	19,83 €	19,02 €	-	-	-	-	-
23,39 €	22,21 €	21,29 €	19,73 €	-	-	-	-
28,41 €	26,74 €	25,33 €	23,17 €	21,87 €	-	-	-
35,40 €	33,45 €	31,76 €	29,26 €	27,72 €	27,86 €	-	-
44,41 €	42,14 €	40,12 €	37,23 €	35,44 €	35,38 €	31,54 €	-

DH

Rejilla retorno

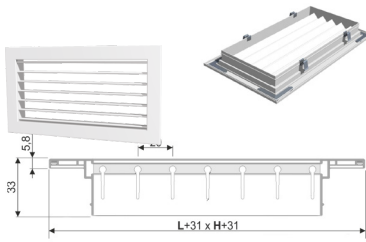

PVP	200	250	300	350	400	450	500	600	700	800	900	1000
100	9,72 €	10,21 €	11,02 €	11,79 €	12,67 €	13,49 €	14,55 €	16,50 €	18,12 €	19,75 €	21,77 €	23,44 €
150	10,91 €	11,60 €	12,28 €	13,68 €	14,20 €	15,98 €	16,11 €	18,29 €	21,37 €	23,40 €	25,82 €	27,92 €
200	12,53 €	13,84 €	14,85 €	16,13 €	17,45 €	19,11 €	20,42 €	23,36 €	25,97 €	26,63 €	31,64 €	34,34 €
250		15,27 €	16,77 €	18,32 €	19,83 €	21,33 €	22,84 €	26,21 €	29,23 €	32,28 €	35,69 €	38,82 €
300			18,99 €	20,40 €	22,19 €	24,47 €	26,29 €	30,22 €	33,87 €	37,51 €	41,56 €	45,25 €
350				22,64 €	24,67 €	26,69 €	28,71 €	35,17 €	39,22 €	44,10 €	49,81 €	53,93 €
400					27,48 €	29,82 €	32,12 €	39,18 €	43,82 €	49,33 €	55,64 €	60,35 €
500		€/PVP					34,58 €	46,04 €	51,71 €	58,21 €	65,55 €	71,26 €
600								52,90 €	59,60 €	67,10 €	75,42 €	82,16 €

DDH

Rejilla impulsión doble

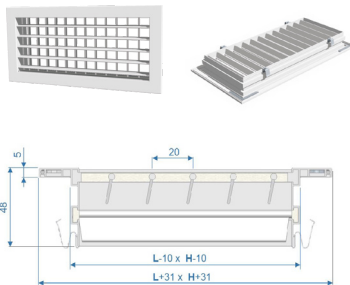

PVP	200	250	300	350	400	450	500	600	700	800	900	1000
100	12,32 €	13,69 €	15,60 €	17,25 €	18,06 €	20,77 €	22,17 €	25,03 €	28,95 €	32,09 €	35,31 €	38,49 €
150	14,56 €	16,27 €	18,13 €	20,03 €	22,01 €	24,78 €	25,77 €	29,75 €	26,09 €	40,18 €	45,35 €	48,48 €
200	17,11 €	19,35 €	21,94 €	24,14 €	26,73 €	28,97 €	31,55 €	36,34 €	44,72 €	49,92 €	55,25 €	60,54 €
250		21,97 €	25,01 €	27,64 €	30,72 €	33,30 €	36,38 €	42,05 €	51,86 €	58,02 €	64,29 €	70,53 €
300			28,66 €	31,78 €	35,43 €	38,51 €	42,16 €	48,89 €	59,49 €	66,15 €	75,20 €	82,59 €
350				35,24 €	39,38 €	42,84 €	46,99 €	56,61 €	67,57 €	76,41 €	85,80 €	93,88 €
400					44,10 €	48,05 €	52,77 €	43,45 €	75,89 €	85,84 €	96,36 €	105,55 €
500		€/PVP					63,37 €	76,03 €	91,12 €	103,12 €	115,67 €	126,90 €
600								94,62 €	112,71 €	125,91 €	139,18 €	152,49 €

CH

Rejilla impulsión curva

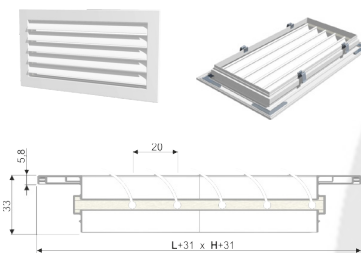

PVP	200	250	300	350	400	450	500	600	700	800	900	1000
100	10,20 €	10,92 €	11,75 €	12,54 €	13,37 €	14,20 €	15,03 €	20,01 €	25,47 €	26,35 €	27,91 €	29,54 €
150	11,44 €	12,62 €	13,70 €	14,78 €	15,86 €	16,94 €	18,02 €	24,15 €	29,47 €	30,69 €	32,72 €	34,81 €
200	16,66 €	16,99 €	17,34 €	17,69 €	18,35 €	19,68 €	21,01 €	28,27 €	33,38 €	35,00 €	37,61 €	40,30 €
250		17,81 €	18,16 €	19,22 €	20,84 €	22,42 €	23,99 €	30,50 €	37,75 €	39,73 €	43,00 €	45,86 €
300			19,71 €	21,46 €	23,29 €	25,16 €	26,98 €	33,11 €	42,14 €	44,61 €	48,01 €	51,61 €
350				23,70 €	27,89 €	29,50 €	31,30 €	41,11 €	46,04 €	49,06 €	52,70 €	56,95 €
400					29,21 €	32,31 €	34,60 €	44,79 €	50,22 €	53,48 €	57,79 €	62,04 €
500		€/PVP					39,98 €	53,56 €	59,72 €	63,99 €	68,57 €	73,81 €
600								65,01 €	67,54 €	71,55 €	78,99 €	84,75 €

LCM

Rejilla impulsión lineal con marco

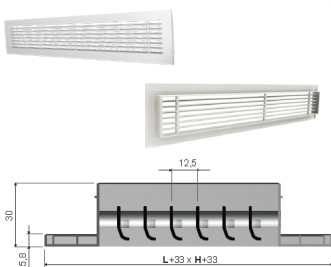

PVP	200	250	300	350	400	450	500	600	700	800	900	1000
100	15,19 €	15,87 €	16,40 €	17,08 €	18,00 €	18,95 €	21,21 €	23,12 €	26,33 €	28,76 €	32,10 €	35,18 €
150	18,29 €	19,44 €	20,92 €	22,55 €	24,17 €	25,95 €	27,28 €	31,16 €	35,42 €	39,56 €	43,56 €	47,40 €
200	21,39 €	23,08 €	25,57 €	27,29 €	29,89 €	31,96 €	35,24 €	39,33 €	44,96 €	49,10 €	54,76 €	58,87 €
250		27,30 €	30,55 €	33,69 €	37,00 €	39,87 €	42,72 €	48,83 €	55,76 €	62,31 €	68,83 €	75,29 €
300			34,41 €	38,01 €	41,84 €	45,43 €	48,83 €	57,03 €	64,62 €	72,33 €	80,05 €	87,81 €
350				42,94 €	47,20 €	51,39 €	55,73 €	64,62 €	73,56 €	82,30 €	91,41 €	100,24 €
400					53,32 €	57,14 €	63,26 €	73,56 €	82,50 €	92,82 €	103,16 €	113,58 €
500		€/PVP					74,74 €	87,63 €	100,47 €	113,39 €	126,22 €	139,16 €
600								99,04 €	113,53 €	128,13 €	142,63 €	157,26 €

Difusor Circular DCI
Difusores

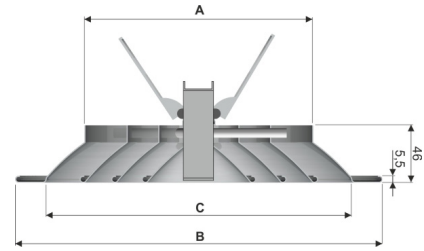
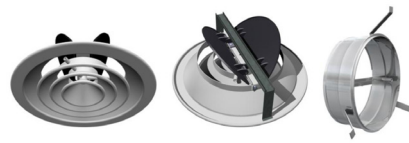

Tamaño	Huecos Instalación	Medidas			Con puente PM+	Puente de montaje	Cuello circular AF
		A	B	C	regulación CM €/P.V.P	PM €/P.V.P	tubo flex €/P.V.P
6" - 150 mm	21 - 22,5 cm	150	260	210	21,15 €	2,74 €	12,85 €
8" - 200 mm	26 - 27,5 cm	200	307	265	26,65 €	2,98 €	12,95 €
10" - 250 mm	31 - 32,5 cm	250	357	315	35,60 €	3,17 €	13,10 €
12" - 300 mm	36 - 37,5 cm	300	407	368	41,55 €	3,27 €	13,15 €
14" - 350 mm	41 - 42,5 cm	350	458	415	47,80 €	3,84 €	13,30 €

Bocas extractoras BC
Accesorios

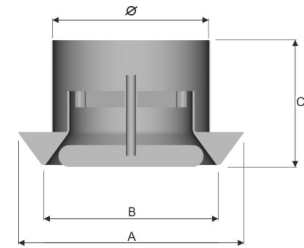

Modelo	Ø	Medidas			P.V.P
		A	B	C	
80 mm	78	120	90	76	4,80 €
100 mm	98	140	110	76	5,35 €
125 mm	122	165	135	76	5,70 €

Larguero para Marcos Rejillas L
Accesorios

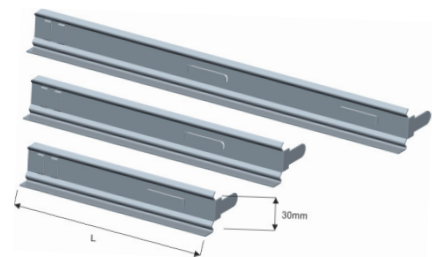

Longitud (L)	P.V.P	Longitud (L)	P.V.P	Longitud (L)	P.V.P	Longitud (L)	P.V.P
100	0,37 €	450	1,33 €	850	2,54 €	1500	5,50 €
125	0,37 €	500	1,50 €	900	2,66 €	1600	6,08 €
150	0,46 €	550	1,62 €	950	2,83 €	1700	6,71 €
200	0,69 €	600	1,79 €	1000	2,96 €	1800	7,40 €
250	0,79 €	650	1,96 €	1100	3,36 €	1900	8,33 €
300	0,92 €	700	2,08 €	1200	3,87 €	2000	8,82 €
350	1,04 €	750	2,25 €	1300	4,38 €		
400	1,21 €	800	2,37 €	1400	4,92 €		

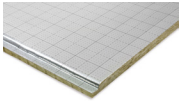

URSA AIR Panel Alu-Alu P5858



Código	Formato	Espesor	Ancho	Largo	Dis	Ud./Pq	m ² /Pq	Pq/palet	m ² /palet	Rt m ² -K/W	P.Net/m ²
107001643	Caja	25 mm	1,20 m	3,00 m	S	6	21,60	7	151,20	0,78	Consultar
107001343	XL	25 mm	1,20 m	3,00 m	S	46	165,60	-	165,60	0,78	Consultar
107001443	XS	25 mm	1,20 m	2,40 m	S	46	132,48	-	132,48	0,78	Consultar

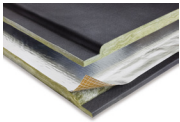

URSA AIR Zero P8858



Código	Formato	Espesor	Ancho	Largo	Dis	Ud./Pq	m ² /Pq	Pq/palet	m ² /palet	Rt m ² -K/W	P.Net/m ²
107001543	Caja	25 mm	1,20 m	3,00 m	S	6	21,60	7	151,20	0,78	Consultar
107001243	XL	25 mm	1,20 m	3,00 m	S	46	165,60	-	165,60	0,78	Consultar
107001243	XS	25 mm	1,20 m	2,40 m	S	46	132,48	-	132,48	0,78	Consultar



MALETÍN NG18



Código	Modelo	P.Net
107005643	Maletín herramientas de corte NG18 TOOL	330,00 €



RECAMBIO CUCHILLAS



Código	Modelo	P.Net
107004843	Kit de recambios de cuchillas EASY TOOL	90,00 €



CUCHILLO URSA AIR



Código	Modelo	P.Net
107004943	Cuchillo URSA AIR	5,40 €



ESPÁTULAS URSA AIR



Código	Modelo	P.Net
107004243	Espátulas URSA AIR	5,90 €



ESCUADRA ALUMINIO



Código	Modelo	P.Net
107005743	Escuadra de aluminio URSA AIR	212,35 €



TRIÁNGULO SCR



Código	Modelo	P.Net
107004743	Triángulo SCR (Sistema conducto recto)	35,00 €



GRAPADORA

Código	Modelo	P.Net
107004543	Grapadora	52,00 €



GRAPAS

Código	Modelo	P.Net
107004643	Grapas (500 Ud)	5,70 €



VENDAS ESCAYOLA

Código	Modelo	P.Net
107004343	Vendas escayola	5,80 €



COLA

Código	Modelo	P.Net
107005143	Bote Cola 6 Kg	11,20 €

Esquema de conexión tipo CON FLEXA 3.0

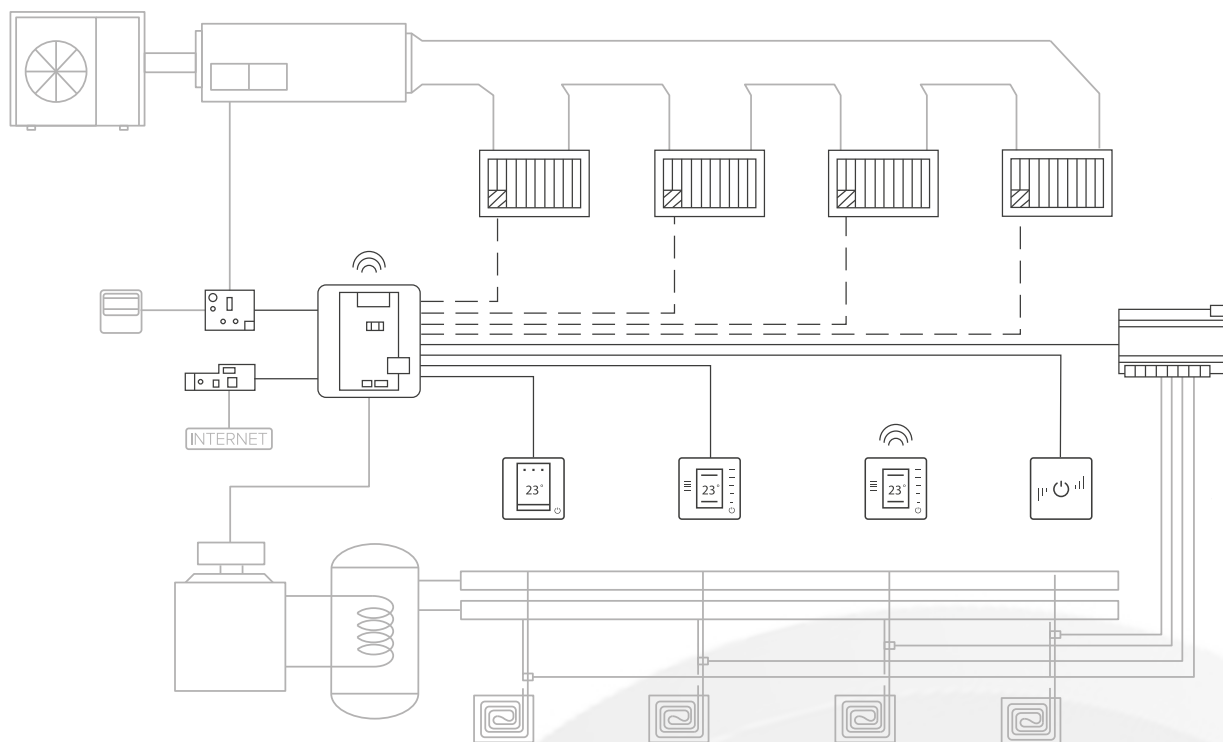

Código	Modelo	Unidad	P.V.P
AZCE6FLEXA3	Central de sistema Flexa 3.0 - 6 zonas	1	220,00 €
AZX6GTC [XXX]	Pasarela Controlador Airzone - [marca]	1	180,00 €
AZCE6BLUEFACEC [B/N]	Termostato cable a color Airzone Blueface [blanco/negro] 8 zonas	1	145,00 €
AZCE6THINKC [B/N]	Termostato cable monocromo Airzone Think [blanco/negro] 8 zonas	1	117,00 €
AZCE6THINKR [B/N]	Termostato radio monocromo Airzone Think [blanco/negro] 8 zonas	1	158,00 €
AZCE6LITEC [B/N]	Termostato cable simplificado Airzone Lite [blanco/negro] 8 zonas	1	81,00 €
RINTO30015BKMRE	Rejilla triple inteligente 300x150 mm blanca	4	152,00 €
AZX6WEBSCLLOUDR	Webserver Airzone Cloud Wi-Fi	1	150,00 €
AZX6CABLEBUS100	Cable bus Airzone (2x0,5 + 2 x 0,22) 100 m	1	68,00 €
AZX6CABLERN100	Cable RN Airzone (2x0,75) 100m	1	50,00 €
TOTAL			1.777,00 €

*Consultar descuentos

Sistema expansión directa con termostato cableado y control wifi con control automático o manual de ventilación

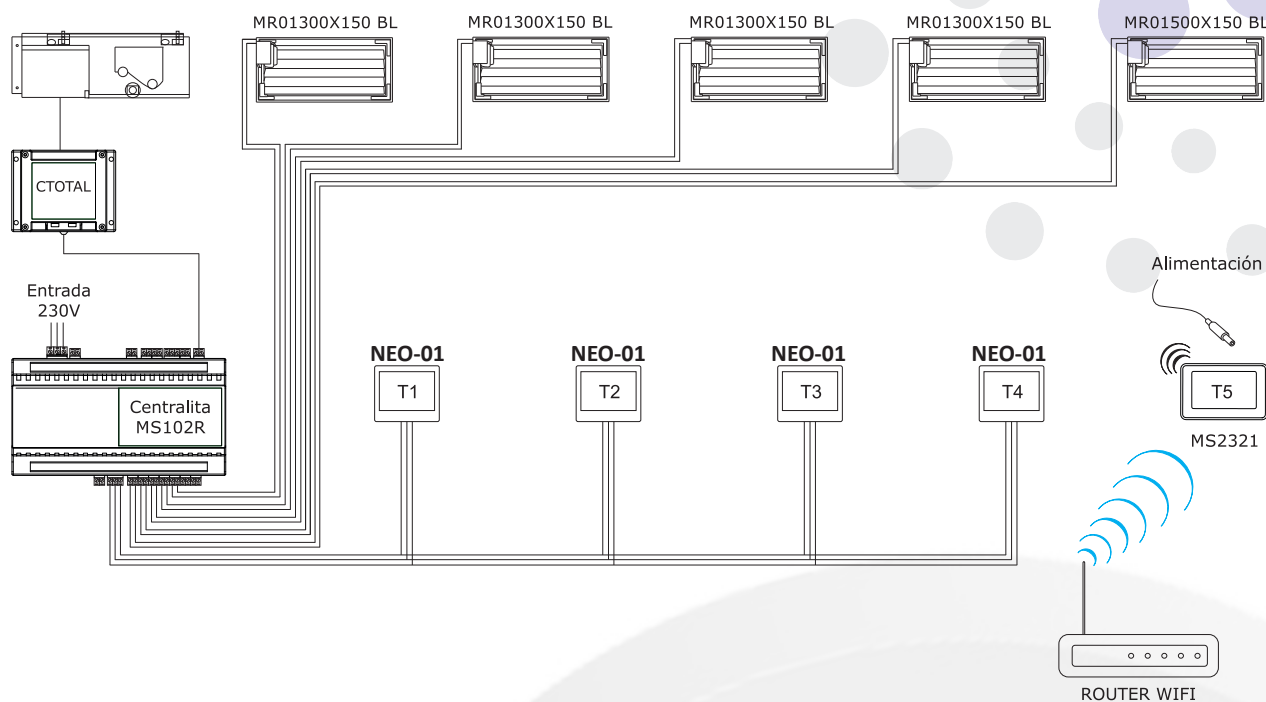

Código	Modelo	Unidad	P.V.P
MS102R	Centralita electrónica elementos inalámbricos	1	215,00 €
NEO-01	Termostato táctil cableado retroiluminado	4	117,00 €
MS2321	Termostato a color con control App	1	250,00 €
MR01300X150 CB	Rejilla de lama motorizada	4	143,30 €
MR01500X150 CB	Rejilla de lama motorizada	1	150,25 €
PASARELA CONTROL TOTAL	Módulo de control de integración con máquina	1	180,00 €
TOTAL			1.836,45 €

***Consultar descuentos**



Cables flexibles y libres de halógenos H07Z1

- Disponible en bobinas de 100m
- Disponible en color azul, gris, marrón y tierra

Modelo	Medidas	P.Neto
Unipolar 1,5 mm	1 x 1,5	13,74 €
Unipolar 2,5 mm	1 x 2,5	22,06 €
Unipolar 4,0 mm	1 x 4	34,64 €
Unipolar 6,0 mm	1 x 6	50,89 €



Cables flexibles y libres de halógenos TRIPLIN H07Z1

- Disponible en bobinas de 100m
- Disponible en color azul, negro, y tierra

Modelo	Medidas	P.Neto
Triplin 3 x 1,5 mm	3G 1,5	37,53 €
Triplin 4 x 1,5 mm	3G 2,5	61,81 €
Triplin 3 x 2,5 mm	4G 1,5	49,96 €



Cables RV-K

- Disponible en rollos de 50m
- Disponible en blanco y negro

Modelo	Medidas	P.Neto
RVK 3 x 1,5 mm	3 x 1,5	24,00 €
RVK 3 x 2,5 mm	3 x 2,5	35,50 €
RVK 3 x 4,0 mm	3 x 4	59,05 €
RVK 4 x 1,5 mm	4 x 1,5	30,00 €
RVK 5 x 1,5 mm	5 x 1,5	37,29 €



Cables RZ1-K libres de halógenos

- Disponible en rollos de 50m

Modelo	Medidas	P.Neto
RZ1K 3 x 1,5 mm	3 x 1,5	33,00 €
RZ1K 3 x 2,5 mm	3 x 2,5	48,45 €
RZ1K 3 x 4,0 mm	3 x 4	69,48 €
RZ1K 4 x 1,5 mm	4 x 1,5	42,00 €
RZ1K 5 x 1,5 mm	5 x 1,5	50,58 €



Rollo tubo corrugado

Código	Medidas	Rollo	P.Neto
607002594	20 mm	100 m	11,85 €
607002694	25 mm	75 m	11,13 €



Rollo tubo corrugado reforzado

Código	Medidas	Rollo	P.Neto
607002794	20 mm	100 m	20,85 €
607002894	25 mm	75 m	27,75 €



Magnetotérmico 2 Polos

Código	Medidas	P.Neto
607000137	10 A	4,05 €
607000237	16 A	4,05 €
6070400337	20 A	4,05 €
607000437	25 A	4,05 €



Diferencial 1 Polo

Código	Medidas	P.Neto
607000537	25 A	14,10 €



Escaleras aluminio multifunción

Código	Medidas	P.Neto
16001610	4x4 Peldaños	92,50 €
106001710	4x5 Peldaños	125,00 €



Escaleras madera

Código	Medidas	P.Neto
106000944	3 Peldaños	30,00 €
106001044	4 Peldaños	39,00 €
106001144	5 Peldaños	45,90 €
106001244	7 Peldaños	62,00 €



Tacos goma

Código	Descripción	P.Neto
106001344	Tacos de goma para escaleras de madera	2,00 € / Ud



Elevador telescópico C-711

Código	Altura Max.	Carga Max.	P.Neto
607001891	3,65 m	130 kg	360,00 €



Juego de ruedas para elevador

Código	Modelo	P.Neto
607001991	Compatible con C-711	37,50 €



Bandeja plataforma elevador

Código	Medidas	P.Neto
607005591	800 x 400 x 50 mm	36,00 €



Cabestrante automático HW-50C

Código	Modelo	Caract.	P.Neto
607005691	Compatible con C-711	Hasta 550 Kg	68,50 €



Carretilla elevadora manual alu. C-800

Código	Altura Max.	Carga Max.	P.Neto
607002091	3,67 m	160 kg	795,00 €



Cabestrante automático HW-80C

Código	Modelo	Caract.	P.Neto
607005791	Compatible con C-800	Hasta 810 Kg	78,12 €



Mini orange



Código	Caudal Max.	P.Neto
107003143	12 L/h	60,94 €



Maxi lime



Código	Caudal Max.	P.Neto
107003243	35 L/h	94,75 €



Mini blanc deluxe



Código	Caudal Max.	P.Neto
107007843	12 L/h	47,87 €



Mini aqua



Código	Caudal Max.	P.Neto
107002943	12 L/h	62,70 €



MAX Hi-Flow



Código	Caudal Max.	P.Neto
107003043	550 L/h	49,79 €

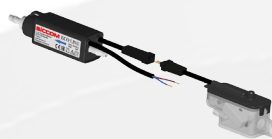

Eco line



Código	Caudal Max.	P.Neto
107002043	13,20 L/h	41,49 €



Flowlta+



Código	Caudal Max.	P.Neto
107001943	13,20 L/h	34,05 €



Mini Flowatch2



Código	Caudal Max.	P.Neto
107002343	151 L/h	49,58 €



Mini Flowatch Clim



Código	Caudal Max.	P.Neto
107002443	151 L/h	50,77 €



Ecotank +2.5



Código	Caudal Max.	P.Neto
107001743	300 L/h	41,32 €



Tubería PVC (2,5 m)

Código	Medidas	P.Neto
107000195	Ø16	1,19 €
107000295	Ø20	1,67 €
107000395	Ø25	1,85 €
107000495	Ø32	2,81 €



Codo 90° PVC

Código	Medidas	P.Neto
107000199	Ø16	0,24 €
107000299	Ø20	0,18 €
107000399	Ø25	0,27 €
107000499	Ø32	0,46 €



Te 90° PVC

Código	Medidas	P.Neto
107001699	Ø16	0,69 €
107001799	Ø20	0,23 €
107001899	Ø25	0,35 €
107001999	Ø32	0,55 €



Abrazadera PVC

Código	Medidas	P.Neto
107004099	Ø16	0,36 €
107004199	Ø20	0,23 €
107004299	Ø25	0,28 €
107004399	Ø32	0,41 €



Espirocristal

Código	Medidas	Rollo	P.Neto/Rollo
107000598	Ø6x9	25 m	5,00 €
107000698	Ø10x14	25 m	11,80 €



Manguitos PVC

Código	Medidas	P.Neto
107001199	Ø16	0,26 €
107001299	Ø20	0,23 €
107001399	Ø25	0,26 €
107001499	Ø32	0,28 €



Codo 45° PVC

Código	Medidas	P.Neto
107000699	Ø16	0,52 €
107000799	Ø20	0,25 €
107000899	Ø25	0,26 €
107000999	Ø32	0,48 €



Tapón PVC

Código	Medidas	P.Neto
107003999	Ø16	0,33 €
107003299	Ø20	0,21 €
107003399	Ø25	0,22 €
107003499	Ø32	0,38 €



- Pegamento tubo
- Pegamento bote pincel
- Limpiador pegamento

Código	Capacidad	P.Neto
107003899	125 ml	2,35 €
107003699	500 ml	9,50 €
107003799	500 ml	5,52 €

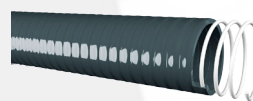

Hidrotubo

Código	Medidas	Rollo	P.Neto/Rollo
107000298	Ø13x16 Blanco	25 m	12,95 €
107000198	Ø13x16 Gris	25 m	12,95 €
107000398	Ø16x20 Blanco	25 m	14,00 €
107000498	Ø16x20 Gris	25 m	14,00 €

**Varillas roscadas**

Código	Modelo	P.Neto
607000812	M 4	0,31 €
607000912	M 6	0,39 €
607001012	M 8	0,75 €

**Manguitos (Blister 10 Ud)**

Código	Modelo	P.Neto
607002712	M 4	0,80 €
607002812	M 6	1,20 €
607002912	M 8	1,90 €

**Taco latón (Blister 10 Ud)**

Código	Modelo	P.Neto
607001912	M 4	0,70 €
607002012	M 6	1,20 €
607002112	M 8	1,80 €

**Basculante**

Código	Modelo	P.Neto
607001712	M 4	0,24 €
607001812	M 8	0,69 €

**Tirafondos (Caja 100 Ud)**

Código	Medidas	P.Neto
607000112	8 x 60 mm	7,00 €
607002412	10 x 60 mm	14,00 €

**Taco multimaterial MZK**

Código	Medidas	P.Neto
6070003188	100 Ud 6 x 30 mm	3,20 €
6070004188	100 Ud 8 x 49 mm	4,50 €
6070005188	50 Ud 10 x 60 mm	4,10 €

**Tuercas (Blister 10 Ud)**

Código	Modelo	P.Neto
607001112	M 4	0,20 €
607001212	M 6	0,30 €
607001312	M 8	0,40 €

**Arandelas (Blister 10 Ud)**

Código	Modelo	P.Neto
607001412	M 4	0,40 €
607001512	M 6	0,60 €
607001612	M 8	0,80 €

**Taco golpe (Blister 10 Ud)**

Código	Modelo	P.Neto
607002512	M 6	0,90 €
607002612	M 8	1,00 €

**DIN-7505A (Caja 500 Ud)**

Código	Modelo	P.Neto
607003012	M 4 5 x 35 mm	7,50 €

**Taco nylon (Caja 100 Ud)**

Código	Medidas	P.Neto
60700612	6 x 30 mm	3,00 €
60700712	10 x 50 mm	5,00 €

**Taco golpe (Caja 100 Ud)**

Código	Medidas	P.Neto
607000412	5 x 30 mm	4,50 €
607000512	6 x 35 mm	5,50 €



Soporte soldado

Código	Medidas	Chapa	P.Netto
107000643	450 x 450 mm	1,5 mm	5,10 €
607002022	500 x 500 mm	2 mm	5,40 €
607004391	600 x 600 mm	2 mm	11,75 €
607005091	600 x 600 mm	3 mm	16,31 €
607000191	1000 x 600 mm	3 mm	22,00 €



Soporte plegable

Código	Medidas	Chapa	P.Netto
607005291	500 x 550 mm	2 mm	9,00 €
607004491	500 x 450 mm	2 mm	7,50 €



Soporte suelo

Código	Medidas	Chapa	P.Netto
607001191	390 mm	2 mm	15,20 €
607001291	490 mm	2 mm	16,20 €



Soporte garrafa / Garrafa

Código	Medidas	Capacidad	P.Netto
607001491	26 x 13 x 22 cm	5 L	8,00 €
607001591	37 x 17 x 24 cm	10 L	9,10 €
607004791	-	5 L	1,09 €
607004891	-	10 L	2,10 €



Pack antivibradores

- Antivibradores 4 Ud
- Tuercas 8 Ud
- Arandelas 8 Ud

Código	Modelo	P.Netto
607002222	A - 35	1,10 €
607002322	A - 45	1,70 €
607005191	A - 50	3,10 €



Pack antivibradores

- Bases circulares 4 Ud
- Tuercas 8 Ud
- Arandelas 8 Ud

Código	Ud. Venta	Modelo	P.Netto
607002422	PACK	S - 40	1,85 €
607002522	PACK	S - 60	2,44 €
607002391	Ud	S - 70	2,20 €
607002491	Ud	S - 100	5,66 €



Alfombrillas

Código	Medidas	P.Netto
607002791	300 x 300 x 10 mm	4,70 €
607002891	380 x 380 x 20 mm	13,00 €



Bases cuadradas

Código	Medidas	P.Netto
607002591	70 x 70 x 25 mm	1,89 €
607002691	80 x 80 x 35 mm	2,66 €



Amortiguador metálico

Código	Modelo	P.Netto
607003491	M-50-B	5,94 €
607003591	M-75-B	6,25 €
607003691	M-125-B	6,25 €
607003791	M-150-B	11,79 €
607003891	M-200-B	11,79 €
607003991	M-250-B	12,99 €



Amortiguador metálico techo

Código	Modelo	P.Netto
607004291	TM-25-MB	5,70 €
607003391	TM-50-MB	5,92 €
607003291	TM-75-MB	7,02 €
607003191	TM-125-MB	7,14 €



Brida nylon

Disponible Blanco y Negro

Código	Medidas	Ud venta	P.Neto
607001292	4,8 x 200 mm	100 Ud	1,52 €
607001492	4,8 x 280 mm	100 Ud	2,62 €
607001992	7,8 x 750 mm	100 Ud	16,85 €



Taco brida

Disponible Blanco y Negro

Código	Medidas	Ud venta	P.Neto
607000992	8 mm	100 Ud	2,57 €



Cintas

Código	Medidas	P.Neto
607000392	50 m x 75 mm Cinta Alu	3,75 €
607000192	50 m x 63 mm Cinta Alu	3,26 €
607000292	50 m x 50 mm Cinta Alu	2,38 €
607002392	50 m x 75 mm Cinta Alu Negro	5,10 €
607002492	50 m x 50 mm Cinta Americana Disp. blanco, negro y gris	3,69 €
607000492	20 m x 19 mm Cinta Aislante Disp. blanco negro y verde y amarillo	0,50 €
607000892	25 m x 50 mm Cinta Aislante Disp. blanco y negro	1,80 €
607002192	10 m x 3 mm Cinta Antigoteo Disp. blanco y negro	3,76 €
607002792	50 m x 63 mm Cinta Tipo Neto	10,80 €



Caja preinstalación

Código	Modelo	Medidas	P.Neto
607000188	Preair 1	350 x 120 x 50 mm	2,28 €
607000288	Preair 2	392 x 134 x 55 mm	2,54 €
607000388	Preair 3	396 x 112 x 55 mm	2,99 €



Condensadores CH

Código	Modelo	P.Neto
201013213	3VF 450V	2,88 €
201013313	3,5VF 450V	3,15 €
201013413	4VF 450V	3,33 €
201013513	5VF 450V	3,51 €
201011813	20VF 450V	4,81 €
201011913	25VF 450V	5,97 €
201012013	30VF 450V	6,48 €
201012113	35VF 450V	6,90 €
201012213	40VF 450V	7,59 €
201012313	45VF 450V	7,80 €
201012413	50VF 450V	7,92 €
201012513	60VF 450V	9,45 €



Condensadores

Código	Modelo	P.Neto
201018413	450V 2MF	1,92 €
201018313	450V 3MF	1,98 €
201012613	450V 5MF	2,04 €
201012713	450V 6MF	2,70 €
201012813	450V 8MF	3,00 €
201012913	450V 10MF	3,30 €
201013013	450V 15MF	3,36 €



Placas electrónicas

Código	Modelo	P.Neto
607005591	ELC-6	25,99 €
607005391	ELC-7	49,00 €



Mando universal

Código	Modelo	P.Neto
607006622	BDT-2000 ORO	9,00 €
607006722	BDT-4000 GRIS	10,50 €



Espumas poliuretano y Masillas

Código	Modelo	P.Neto
201018813	Canula Espuma 750ml	3,97 €
201018913	Pistola Espuma 750ml	3,97 €
201018213	Masilla Acrí. Blanca 300ml	1,26 €
201018513	Silicona Blanca 280ml	1,68 €
201018613	Sellador Polipro. Blanco 300ml	3,82 €



Tratamientos de limpieza para aire acondicionado

Código	Modelo	P.Neto
6070002223	AIRPUR 750ml	42,50 €
6070003223	AIRNET 750 ml	8,50 €



ALICATES UNIVERSALES

Código	Modelo	P.Neto
607004512	Alicates universales 6" 160 mm	6,75 €



ALICATES DE CORTE

Código	Modelo	P.Neto
607004812	Alicates de corte diagonal 6" 160 mm	6,90 €



ALICATES PUNTA RECTA

Código	Modelo	P.Neto
607004612	Alicates de punta recta 6" 160 mm	6,75 €



TENAZAS DE CANAL

Código	Modelo	P.Neto
607004712	Tenazas de canal 10" 250mm	12,00 €



CUTTER

Código	Modelo	P.Neto
607002212	Cutter + 3 cuchillos	2,00 €



CUCHILLAS

Código	Modelo	P.Neto
607002312	Hojas de recambio cutter	0,80 €



TIJERAS CORTE CHAPA

Código	Modelo	P.Neto
607004912	Tijeras articuladas 250 mm 10"	9,20 €



TIJERAS ELECTRICISTA

Código	Modelo	P.Neto
607006512	Tijeras electricista 150 mm	9,70 €



NIVEL ALUMINIO

Código	Modelo	P.Neto
607006212	Escala graduada, long. 500 mm	10,35 €



FLEXÓMETRO 5M

Código	Modelo	P.Neto
607006312	Flexómetro recubierto de goma 5m	2,75 €



MACETA

Código	Modelo	P.Neto
607005312	Martillo modelo Español 700gr	10,35 €



MARTILLO

Código	Modelo	P.Neto
607006612	Martillo ebanista C-22 230gr	5,90 €



PISTOLA SILICONA

Código	Modelo	P.Neto
607006412	Pistola de silicona capacidad 310 ml	7,50 €



LLAVE INGLESA

Código	Modelo	P.Neto
607008212	10" Apertura 33 mm	12,00 €



Canaleta

Código	Ud. Venta	Medidas	P.V.P
107000123	BARRAS 2 m	15 x 17 mm	1,30 €
107000223	BARRAS 2 m	25 x 30 mm	3,45 €
107000323	BARRAS 2 m	60 x 40 mm	5,08 €
107000423	BARRAS 2 m	60 x 60 mm	6,08 €
107000523	BARRAS 2 m	80 x 40 mm	7,34 €
107000623	BARRAS 2 m	100 x 60 mm	9,94 €
107002723	BARRAS 2 m	120 x 60 mm	10,36 €
107002823	BARRAS 2 m	150 x 60 mm	19,58 €
107002923	BARRAS 2 m	200 x 60 mm	22,16 €



Tapa terminal

Código	Medidas	P.V.P
107000723	60 x 40 mm	0,87 €
107000823	60 x 60 mm	0,90 €
107000923	80 x 40 mm	0,95 €
107001023	100 x 60 mm	1,00 €
107004623	120 x 60 mm	1,04 €
107003923	150 x 60 mm	1,08 €
107004023	200 x 60 mm	1,61 €



Ángulo plano

Código	Medidas	P.V.P
107002023	60 x 40 mm	3,31 €
107002123	60 x 60 mm	3,27 €
107002223	80 x 40 mm	3,28 €
107002323	100 x 60 mm	3,92 €
107003023	120 x 60 mm	8,28 €
107003123	150 x 60 mm	8,39 €
107003223	200 x 60 mm	10,69 €



Ángulo interior variable

Código	Medidas	P.V.P
107001623	60 x 40 mm	1,66 €
107001723	60 x 60 mm	1,97 €
107001823	80 x 40 mm	2,15 €
107001923	100 x 60 mm	2,50 €
107003623	120 x 60 mm	2,62 €
107003723	150 x 60 mm	4,76 €
107003823	200 x 60 mm	6,16 €



Ángulo exterior variable

Código	Medidas	P.V.P
107001123	60 x 40 mm	1,61 €
107001323	60 x 60 mm	2,11 €
107001423	80 x 40 mm	2,25 €
107001523	100 x 60 mm	2,40 €
107003323	120 x 60 mm	2,51 €
107003423	150 x 60 mm	6,99 €
107003523	200 x 60 mm	7,04 €

**Rollos monotubo - Rollos 25m**

Código	Dimensiones	Presión Max.	Marcado	Precio Ud. Rollo 25m	Precio Ud. 10 Rollos 25m
607002185	1/4"	Máximo 55 bar	KLIMA	Consultar	Consultar
607003185	3/8"	Máximo 55 bar	KLIMA	Consultar	Consultar
607004185	1/2"	Máximo 55 bar	KLIMA	Consultar	Consultar
607005185	5/8"	Máximo 57 bar	PLUS	Consultar	Consultar
607012022	1/4"	Máximo 57 bar	PLUS	Consultar	Consultar
607012122	3/8"	Máximo 57 bar	PLUS	Consultar	Consultar
607012222	1/2"	Máximo 57 bar	PLUS	Consultar	Consultar
607012322	5/8"	Máximo 65 bar	EXTRA	Consultar	Consultar
607000185	3/4"	Máximo 65 bar	EXTRA	Consultar	Consultar

**Rollos monotubo - Rollos 50m**

Código	Dimensiones	Presión Max.	Marcado	Precio Ud. Rollo 50m	Precio Ud. 10 Rollos 50m
607000285	1/4"	Máximo 57 bar	PLUS	Consultar	Consultar
607000385	3/8"	Máximo 57 bar	PLUS	Consultar	Consultar
607000885	1/2"	Máximo 57 bar	PLUS	Consultar	Consultar
607000485	5/8"	Máximo 57 bar	PLUS	Consultar	Consultar

**Rollos bitubo aislado - Rollos 20m**

Código	Dimensiones	Presión Max.	Marcado	Precio Ud. Rollo 20m	Precio Ud. 10 Rollos 20m
607001085	1/4" x 3/8"	Máximo 55 bar	KLIMA	Consultar	Consultar
607002422	1/4" x 1/2"	Máximo 55 bar	KLIMA	Consultar	Consultar
607001585	3/8" x 5/8"	Máximo 55/57 bar	KLIMA - PLUS	Consultar	Consultar
607001385	1/4" x 3/8"	Máximo 57 bar	PLUS	Consultar	Consultar
607001485	1/4" x 1/2"	Máximo 57 bar	PLUS	Consultar	Consultar
607001685	1/4" x 5/8"	Máximo 57/65 bar	PLUS - EXTRA	Consultar	Consultar
607002085	3/8" x 5/8"	Máximo 57/65 bar	PLUS - EXTRA	Consultar	Consultar
607000785	3/8" x 3/4"	Máximo 57 bar	PLUS	Consultar	Consultar

**Rollos cobre - Rollos 15m "Copper brass" homologado**

Código	Dimensiones	Presión Max.	Espesor pared	Precio Ud. Rollo 15m	Precio Ud. 10 Rollos 15m
607000422	1/4"	Máximo 57 bar	0,80 m/m	Consultar	Consultar
607000522	3/8"	Máximo 57 bar	0,80 m/m	Consultar	Consultar
607000622	1/2"	Máximo 57 bar	0,80 m/m	Consultar	Consultar
607000722	5/8"	Máximo 57 bar	0,80 m/m	Consultar	Consultar
607000822	3/4"	Máximo 65 bar	1,00 m/m	Consultar	Consultar
607000585	7/8"	Máximo 65 bar	1,00 m/m	Consultar	Consultar

**Rollos cobre - Rollos 15m Frigoline**

Código	Dimensiones	Presión Max.	Espesor pared	Precio Ud. Rollo 15m	Precio Ud. 10 Rollos 15m
607000685	1/4"	Máximo 55 bar	0,76 m/m	Consultar	Consultar
607000985	3/8"	Máximo 55 bar	0,76 m/m	Consultar	Consultar
607002522	1/2"	Máximo 55 bar	0,76 m/m	Consultar	Consultar
607002622	5/8"	Máximo 57 bar	0,80 m/m	Consultar	Consultar

**Tubería cobre - Barra 4m**

Código	Dimensiones	Presión Max.	Espesor pared	Precio Ud. Barra 4m	Precio Ud. Barra 4m
607001185	3/8"	Máximo 57 bar	0,80 m/m	Consultar	Consultar
607001285	1/2"	Máximo 57 bar	0,80 m/m	Consultar	Consultar
607001385	5/8"	Máximo 57 bar	0,80 m/m	Consultar	Consultar
607001485	3/4"	Máximo 65 bar	1,00 m/m	Consultar	Consultar
607001585	7/8"	Máximo 65 bar	1,00 m/m	Consultar	Consultar
607001685	1"	Máximo 65 bar	1,00 m/m	Consultar	Consultar
607001785	1 1/8"	Máximo 65 bar	1,00 m/m	Consultar	Consultar
607001885	1 3/8"	Máximo 70 bar	1,25 m/m	Consultar	Consultar
607001985	1 5/8"	Máximo 70 bar	1,25 m/m	Consultar	Consultar

**Coquilla aislamiento isoline - Barra 2m**

Código	Dimensiones	Pulgadas en Cobre	Pulgadas en Acero	Precio Ud. Barras sueltas	Precio Ud. Caja completa	Uds. Caja
107000185	06 x 06 m/m	1/4"	-	0,43 €	0,38 €	248
107000285	06 x 10 m/m	3/8"	1/8"	0,54 €	0,48 €	182
107000385	06 x 12 m/m	1/2"	-	0,58 €	0,51 €	158
107000485	06 x 15 m/m	5/8"	1/4"	0,65 €	0,58 €	133
107000585	06 x 18 m/m	3/4"	3/8"	0,83 €	0,74 €	110
107000685	06 x 22 m/m	7/8"	1/2"	0,94 €	0,83 €	90
107000785	09 x 06 m/m	1/4"	-	0,61 €	0,54 €	176
107000885	09 x 10 m/m	3/8"	1/8"	0,65 €	0,58 €	133
107000985	09 x 12 m/m	1/2"	-	0,68 €	0,61 €	117
107001085	09 x 15 m/m	5/8"	1/4"	0,79 €	0,70 €	96
107001185	09 x 18 m/m	3/4"	3/8"	0,83 €	0,74 €	83
107001285	09 x 22 m/m	7/8"	1/2"	0,90 €	0,80 €	68
107002585	09 x 25 m/m	1"	-	0,97 €	0,86 €	54
107003585	09 x 28 m/m	1 1/8"	3/4"	1,15 €	1,02 €	49
107003685	09 x 35 m/m	1 3/8"	1"	1,37 €	1,22 €	38
107003785	09 x 42 m/m	1 5/8"	1 1/4"	2,02 €	1,79 €	30

* Consultar para más medidas

RAE no incluido. Precios sin IVA, la empresa se reserva el derecho a modificar precios en cualquier momento y si se evidencia cualquier errata.

**Curva 90º H-H**

Código	Medidas	P.Netto
107004313	1/4"	0,31 €
107004413	3/8"	0,33 €
107004513	1/2"	0,35 €
107004613	5/8"	0,60 €
107004713	3/4"	0,87 €
107004813	7/8"	1,13 €
107012113	1"	1,95 €
107012213	1 1/8"	2,22 €
107012313	1 3/8"	3,55 €
107012413	1 5/8"	5,46 €

**Codo 90º H-H**

Código	Medidas	P.Netto
107005413	1/4"	0,23 €
107005513	3/8"	0,25 €
107005613	1/2"	0,28 €
107005713	5/8"	0,35 €
107005813	3/4"	0,61 €
107005913	7/8"	0,84 €
-	1"	-
107015313	1 1/8"	1,62 €
107016313	1 3/8"	2,47 €
107016413	1 5/8"	3,84 €

**Curva 45º H-H**

Código	Medidas	P.Netto
107006613	1/4"	0,25 €
107006713	3/8"	0,28 €
107006813	1/2"	0,29 €
107006913	5/8"	0,36 €
107007013	3/4"	0,58 €
107007113	7/8"	0,86 €
107015113	1"	1,16 €
107012513	1 1/8"	1,59 €
107012613	1 3/8"	2,17 €
107012713	1 5/8"	3,33 €

**Sifón**

Código	Medidas	P.Netto
-	1/4"	-
-	3/8"	-
-	1/2"	-
107007213	5/8"	2,91 €
107007313	3/4"	5,58 €
107007413	7/8"	6,24 €
-	1"	-
107013213	1 1/8"	9,60 €
107013313	1 3/8"	14,10 €
107013413	1 5/8"	26,63 €

**Curva 180º H-H**

Código	Medidas	P.Netto
107007513	1/4"	0,36 €
107007613	3/8"	0,65 €
107007713	1/2"	0,78 €
107007813	5/8"	1,05 €
107007913	3/4"	1,89 €
107008013	7/8"	2,48 €
-	1"	-
107016513	1 1/8"	4,18 €
107016613	1 3/8"	6,83 €
107016713	1 5/8"	11,56 €

**Unión**

Código	Medidas	P.Netto
107008713	1/4"	0,11 €
107008813	3/8"	0,14 €
107008913	1/2"	0,17 €
107009013	5/8"	0,25 €
107009113	3/4"	0,37 €
107009213	7/8"	0,54 €
107012813	1"	0,78 €
107012913	1 1/8"	1,01 €
107013013	1 3/8"	1,44 €
107013113	1 5/8"	2,16 €

**Te H-H**

Código	Medidas	P.Netto
107009313	1/4"	0,27 €
107009413	3/8"	0,37 €
107009513	1/2"	0,44 €
107009613	5/8"	0,69 €
107009713	3/4"	1,17 €
107009813	7/8"	1,69 €
107015413	1"	2,59 €
107015513	1 1/8"	2,91 €
107015613	1 3/8"	3,95 €
107015713	1 5/8"	6,28 €

**Reducciones H-H**

Código	Medidas	P.Netto
107011013	3/8" x 1/4"	0,18 €
107011113	1/2" x 1/4"	0,23 €
107011213	1/2" x 3/8"	0,24 €
107016813	5/8" x 1/4"	0,39 €
107011313	5/8" x 3/8"	0,29 €
107011413	5/8" x 1/2"	0,31 €
107011513	3/4" x 3/8"	0,44 €
107011613	3/4" x 1/2"	0,46 €
107011713	3/4" x 5/8"	0,48 €
107011813	7/8" x 1/2"	0,65 €
107011913	7/8" x 5/8"	0,67 €
107012013	7/8" x 3/4"	0,69 €
107016913	1 1/8" x 1/2"	1,14 €
107017013	1 1/8" x 5/8"	1,15 €
107017113	1 1/8" x 3/4"	1,18 €
107017213	1 1/8" x 7/8"	1,20 €
107017313	1 3/8" x 5/8"	1,41 €
107017413	1 3/8" x 3/4"	1,43 €
107017513	1 3/8" x 7/8"	1,47 €
107017613	1 3/8" x 1 1/8"	1,50 €
107017713	1 5/8" x 5/8"	2,40 €
107017813	1 5/8" x 7/8"	2,52 €
107017913	1 5/8" x 1 1/8"	2,58 €
107018013	1 5/8" x 1 3/8"	2,62 €

Nuevo modelo VRS-120i-01 con mayor plataforma
apta para envases grandes de gas refrigerante
(50-60 kg de carga)



HERRAMIENTAS

AIRE ACONDICIONADO Y REFRIGERACIÓN

NEW





V-H215S-V MINI SERIES

Bombas de vacío de doble efecto R-32 Pump series



Código	Caudal 50/60Hz (L/Min)	Potencia 50/60Hz (W)	Vacío final (Micron)	Conexiones	Dimensiones	Peso (Kg)	Carga aceite (MI)	P.Netto
201028913	42	150	15	1/4"	240 x 88 x 183	5,10	110	110,00 €



V-I YR32 SERIES

Bombas de vacío de doble efecto R-32 Pump series



Código	Caudal 50/60Hz (L/Min)	Potencia 50/60Hz (W)	Vacío final (Micron)	Conexiones	Dimensiones	Peso (Kg)	Carga aceite (MI)	P.Netto
201025113	51	248	15	1/4"	318 x 124 x 265	9	200	137,50 €
201009113	100	373	15	1/4"	338 x 138 x 248	11	325	189,50 €



V-I YR32 SERIES

Bombas de vacío de doble efecto R-32 Pump series



Código	Caudal 50/60Hz (L/Min)	Potencia 50/60Hz (W)	Vacío final (Micron)	Conexiones	Dimensiones	Peso (Kg)	Carga aceite (MI)	P.Netto
201029013	340	746	15	1/4" - 3/8"	345 x 135 x 280	11,5	500	360,00 €



V-RP SERIES

Bombas de vacío de doble efecto R-32 Pump series



Código	Caudal 50/60Hz (L/Min)	Potencia 50/60Hz (W)	Vacío final (Micron)	Conexiones	Dimensiones	Peso (Kg)	Carga aceite (MI)	P.Netto
201029113	170	560	15	1/4" - 3/8"	346 x 145 x 302	11,5	600	315,00 €



ACEITE PARA BOMBAS DE VACÍO

Código	Modelo	Viscosidad	Capacidad (L)	Tipo	P.Neto
201029213		46	0,25	Mineral	4,70 €
201029313		68	1	Mineral	7,00 €
201027513	TL-68	68	1	Éster	10,00 €



VACUÓMETROS

Código	Modelo	Diámetro	Unidades	P.Neto
201006913	Vacuómetro conexión radial 1/8" NPT M	68 mm	mbar	14,30 €



BÁSCULA DIGITAL INALÁMBRICA VRS-i-01

Código	Modelo	Peso Max.	P.Neto
201009713	VRS-50i-01	50 Kg	95,00 €
201029413	VRS-100i-01	100 Kg	100,00 €



BÁSCULA DIGITAL VES-A

Código	Modelo	Peso Max.	P.Neto
201009813	VES-50A	50 Kg	85,00 €
201029513	VES-50A Programable	50 Kg	130,00 €
201002613	VES-100A	100 Kg	94,00 €
201029613	VES-100A Programable	100 Kg	155,00 €



VRR12L+LP ANALÓGICA

- Parada auto. al finalizar recuperación (LP)

Código	Modelo	Motor	Compresor	Vapor (Kw)	Liquid (Kw)	Push/Pull	Medi. (mm)	Peso (Kg)	P.Neto
201000313	VRR12L+LP	3/4CV	1 Pistón, en seco	12	96	276	400x250x355	13,00	369,00 €



VRR12L-R32 ANALÓGICA

- Parada auto. al finalizar recuperación (LP)
- Apta para inflamables



Código	Modelo	Motor	Compresor	Vapor (Kw)	Liquid (Kw)	Push/Pull	Medi. (mm)	Peso (Kg)	P.Neto
201029713	VRR12L+R32	3/4CV	1 Pistón, en seco	15	108	336	400x250x355	13,00	425,00 €



VRR12LOS-R32 ANALÓGICA

- Parada auto. al finalizar recuperación (LP)
- Apta para inflamables



Código	Modelo	Motor	Compresor	Vapor (Kw)	Liquid (Kw)	Push/Pull	Medi. (mm)	Peso (Kg)	P.Neto
201009913	VRR12LOS-R32	3/4CV	1 Pistón, en seco	15	132	378	400x250x355	14,20	515,00 €



VRR24M-C DIGITAL

- Parada auto. al finalizar recuperación (LP)
- Apta para inflamables



Código	Modelo	Motor	Compresor	Vapor (Kw)	Liquid (Kw)	Push/Pull	Medi. (mm)	Peso (Kg)	P.Neto
201029813	VRR24M-C	1CV	Sin escobillas, 2 Pistones	32	252	570	370x250x297	11,00	725,00 €



VRR24L-32 ANALÓGICA

- Parada auto. al finalizar recuperación (LP)
- Apta para inflamables



Código	Modelo	Motor	Compresor	Vapor (Kw)	Liquid (Kw)	Push/Pull	Medi. (mm)	Peso (Kg)	P.Neto
201029913	VRR24L-R32	1CV	2 Pistones, en seco	30	210	510	450x250x355	13,50	555,00 €



VRR12LOS-R32 ANALÓGICA

- Parada auto. al finalizar recuperación (LP)
- Apta para inflamables



Código	Modelo	Motor	Compresor	Vapor (Kw)	Liquid (Kw)	Push/Pull	Medi. (mm)	Peso (Kg)	P.Neto
201000513	VRR24L-OS-R32	1CV	2 Pistones, en seco	30	231	570	400x250x355	14,70	629,00 €



ABOARDADOR VFT-808



Código	Modelo	Para diámetros	Incluye	Embalaje	P.Neto
201016513	VFT-808-IS	1/4" - 5/16" - 3/8" - 1/2" - 5/8" - 3/4"	Cortatubos VTC-28B	Maletín	45,00 €



ABOARDADOR VFT-808-U-I



Código	Modelo	Para diámetros	Incluye	Embalaje	P.Neto
201030013	VFT-808-U-I	1/4" - 5/16" - 3/8" - 1/2" - 5/8" - 3/4"	-	Maletín	52,00 €



ABOARDADOR VFT-809



Código	Modelo	Para diámetros	Incluye	Embalaje	P.Neto
201027313	VFT-809-IS	1/4" - 5/16" - 3/8" - 1/2" - 5/8" - 3/4"	Cortatubos VTC-28B	Maletín	61,00 €

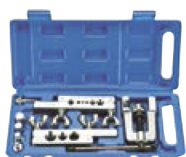

ABOARDADOR ENSANCHATUBOS



Código	Modelo	Para diámetros	Incluye	Embalaje	P.Neto
201019813	CT-275	1/8" - 3/16" - 1/4" - 5/16" - 3/8" - 7/16" - 1/2" - 5/8" - 3/4"		Maletín	29,00 €



ABOARDADOR



Código	Modelo	Para diámetros	Incluye	Embalaje	P.Neto
201015513	275-FS	1/4" a 3/4"	-	Maletín	99,00 €
201015813	525-F	3/16" a 5/8"	-	-	55,00 €



ENSANCHATUBOS VST-22B
Abocardadores y ensanchatubos



Código	Modelo	Para diámetros	P.Neto
201005613	VST-22B	1/4"- 3/8"- 1/2"- 5/8"- 3/4"- 7/8"	22,50 €



ENSANCHATUBOS A GOLPE
Abocardadores y ensanchatubos



Código	Modelo	Para diámetros	P.Neto
107014613	CT-193	1/4"- 5/16"- 3/8"- 1/2"- 5/8"	6,05 €



ENSANCHATUBOS HIDRÁULICO
Abocardadores y ensanchatubos



Código	Modelo	Para diámetros	P.Neto
201019713	VHE-29A	3/8"- 1/2"- 5/8"- 3/4"- 7/8"- 1"- 1 1/8"	192,50 €

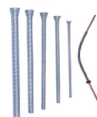

MUELLES DOBLATUBOS
Doblatubos y cortatubos



Código	Modelo	P.Neto
201010113	1/4"	1,07 €
201010213	3/8"	1,73 €
201010313	1/2"	1,93 €
201010413	5/8"	2,10 €
201010513	3/4"	2,15 €



DOBLATUBOS DE CARRACA
Doblatubos y cortatubos



Código	Modelo	Para diámetros	Incluye	Embalaje	P.Neto
201026613	CT999F	1/4"- 5/16"- 3/8"- 1/2"- 5/8"- 3/4"- 7/8"	Escariador cortatubos	Maletín	87,20 €



CORTATUBOS
Doblatubos y cortatubos



Código	Modelo	Para diámetros	Incluye	Embalaje	P.Neto
201015713	TC-1000	1/8" a 1 1/8"	Rueda recambio y escariador	-	23,70 €
201015613	TC-1050	1/8" a 5/8"	-	-	13,90 €



CORTATUBOS
Doblatubos y cortatubos



Código	Modelo	P.Neto
103001804	3 a 16 mm	5,20 €
103001104	3 a 30 mm	9,40 €
103001204	3 a 35 mm	15,05 €
103001504	6 a 76 mm	38,05 €



JUEGO 2 CUCHILLAS
Doblatubos y cortatubos



Código	Modelo	P.Neto
103001904	19 x 5	3,10 €



PUENTE MANÓMETRO 1VÍA CLASE 0.4

- Mangueras: 1 roja de 1/4" - 5/16". 1 amarilla de 1/4" - 1/4".
- 1 x conector 1/4" H giratoria x 5/16" M para R-410A.
- Maletín robusto.



PUENTE MANÓMETRO 2VÍAS CLASE 0.4

- Mangueras: 1 roja y 1 azul de 1/4" - 5/16". 1 amarilla de 1/4" - 1/4".
- 2 x conector 1/4" H giratoria x 5/16" M para R-410A.
- Maletín robusto.



Código	Modelo	P.Neto
201030113	Puente de manómetros digital 1 Vía	77,00 €

Código	Modelo	P.Neto
201009513	Puente de manómetros digital 2 Vías con visor	159,00 €



PUENTE DE MANÓMETROS DIGITAL VDG-1

- Pinza para medir la temperatura.
- Acoplamiento rápidos para AUTO (Alta y Baja, 1/4" SAE M).
- Mangueras de carga.
- 2 x conector 5/16" H giratoria x 1/4" M para R-410A.
- Batería: 4 x pilas AA de 1,5 V.
- Maletín robusto.



Código	Modelo	P.Neto
201009613	Puente de manómetros digital VDG-1	174,00 €
201019613	Sonda de mordaza para VDG-1	27,50 €



PUENTE MANÓMETRO DIGITAL



PUENTE MANOMETROS 2 VÍAS 68mm

- Puente de aluminio.
- Mandos con alta resistencia a los golpes.
- Visor incorporado



Código	Modelo	P.Neto
607001586	Testo 550	269,00 €

Código	Ø	Refrigerante	P.Neto
201006313	68	R32, R410A, R407C	26,50 €
201030213	68	R410A, R32, R407C, R134a, R22	25,00 €



KIT 2 VÍAS

- Puente de aluminio.
- Mandos con alta resistencia a los golpes.
- Maletín robusto.
- Juego de 3 mangueras.



Código	Ø	Refrigerante	Incluye	P.Neto
201009013	80	R410A, R407C, R134a, R404A	2 Rácores 1/4" H x 5/16" M	50,00 €
211007206	80	R32, R410A, R407C, R134a,	-	52,00 €



PUENTE MANOMETROS 2 VÍAS 80mm

- Puente de aluminio.
- Mandos con alta resistencia a los golpes.
- Visor incorporado



Código	Ø	Refrigerante	P.Neto
201030313	80	R32, R410A, R407C, R134a	32,00 €
201030413	80	R404A, R407C, R134a, R22	30,00 €



MANÓMETROS GLICERINA



Código	Ø	Presión	Refrigerante	P.Neto
201008513	80	A	R22, R404A, R134a	9,57 €
201008613	80	B	R22, R404A, R134a	9,57 €
201008713	80	A	R410A, R22, R404A, R134a	14,85 €
201008813	80	B	R410A, R22, R404A, R134a	14,85 €



MANÓMETROS



Código	Ø	Presión	Refrigerante	P.Neto
201008413	80	B	R410A, R407C, R134a, R22	6,75 €
201008313	80	A	R410A, R407C, R134a, R22	6,75 €
201002913	80	B	R410A, R407C, R404A, R134a	6,75 €
201002813	80	A	R410A, R407C, R404A, R134a	6,75 €
201022513	80	B	R32, R410A, R407C, R134a	6,75 €
201022613	80	A	R32, R410A, R407C, R134a	6,75 €
201030513	80	A	R449A, R404A, R452A, R134a	6,75 €
201030613	80	B	R449A, R404A, R452A, R134a	6,75 €

**MANGUERAS DE CARGA PREMIUM**

-Máxima presión de trabajo: 800 psi (55 bar).
-Mínima presión de estallido: 4000 psi (276 bar).



Código	Longitud	Conexión	Modelo	Válvula	P.Netto
201022713	0,9 m	1/4" x 45º 1/4"	-	NO	12,10 €
201006413	1,5 m	1/4" x 45º 1/4"	-	NO	14,85 €
201027113	0,9 m	1/4" x 45º 1/4"	-	SI	22,00 €
201025413	1,5 m	1/4" x 45º 1/4"	-	SI	26,95 €
201022813	0,9 m	1/4" x 45º 5/16"	R410A/R32	NO	13,75 €
201006513	1,5 m	1/4" x 45º 5/16"	R410A/R32	NO	18,15 €
201023113	0,9 m	1/4" x 45º 5/16"	R410A/R32	SI	22,00 €
201025313	1,5 m	1/4" x 45º 5/16"	R410A/R32	SI	26,95 €

**RECAMBIOS PARA MANGUERAS**

Código	Longitud	P.Netto
201004913	Junta teflón manguera 1/4" y 5/16"	0,65 €

**VENTILADORES MULTIANCLAJE****ASPAS VENTILADOR**

Código	Modelo	P.Netto
607011422	5w	6,50 €
607011522	10w	7,50 €
607011622	16w	9,20 €
607011722	25w	12,00 €

Código	Modelo	P.Netto
607000316	3 Palas	1,35 €
607009922	5 Palas	1,50 €

**ACEITES SINTÉTICOS POE**

Código	Descripción	Capacidad	Viscosidad	P.Netto
201021413	THUNDER POE TL-32	5 L	32	46,75 €
201021513	THUNDER POE TL-68	5 L	68	46,75 €

**ACEITES MINERALES**

Código	Descripción	Capacidad	Viscosidad	P.Netto
201021613	THUNDER POE T35 - 32	5 L	32	21,30 €
201021713	THUNDER POE TL-45 - 68	5 L	68	21,30 €

* Para otras viscosidades y formatos, consultar.

**KIT DE PRUEBAS CON NITRÓGENO**

- Regulador de nitrógeno 50 bar.
- 3 juntas entrada regulador.
- Manguera pruebas 3 mt con racores 1/4" SAE.
- Maleta de transporte 37 x 31 x 14 cm

SUPPLYGAS®**KIT TEST INST. CON NITRÓGENO**

- Manómetro Ø 80mm y manguera para test de instalaciones.
- Incluye válvula de corte y racores 1/4" SAE.

SUPPLYGAS®

Código	Modelo	P.Netto
106001402	Equipo de pruebas Mod. CPN503A	125,00 €

Código	Modelo	P.Netto
106001502	Kit test instalaciones	58,00 €

**MANGUERA DE PRUEBAS CON NITRÓGENO (ALTA PRESIÓN)****SUPPLYGAS®**

Código	Artículo	Longitud	P.Netto
106001602	Manguera AP nitrógeno 100 bar	3 m	19,90 €
106001702	Manguera AP nitrógeno 100 bar	5 m	23,85 €
106015402	Manguera AP nitrógeno 100 bar	10 m	42,50 €

* Consultar para más modelos

**REGULADORES ALTA PRESIÓN (200 BAR)****SUPPLYGAS®**

Código	Gas	P. Entrada	P. Salida	Caudal	C. Salida	P.Netto
106012002	Nitrógeno	200 bar	50 bar	100 Nm ³ /h	1/4" SAE	97,50 €

**REGULADORES ALTA PRESIÓN (300 BAR)****SUPPLYGAS®**

Código	Gas	P. Entrada	P. Salida	Caudal	C. Salida	P.V.P.
106001002	Oxígeno / Inertes	300 bar	50 bar	100 Nm ³ /h	1/4" D.	109,70 €

**BOTELLA NITRÓGENO**

Código	Gas	P.V.P.
ENVASE + CARGA NITRÓGENO. VARIAS MEDIDAS	NITRÓGENO	Consultar precio pag. 63



GASES REFRIGERANTES

Refrigerante	Sustitución / Alternativa	Aceite	Deslizamiento	Tasa	P.V.P.
R-134A	Sustitución R-12	POE	0 °C	21,45€	Consultar
R-410A	-	POE	0,5 °C	31,31€	Consultar
R-407C	Sustitución R-22	POE	7,4 °C	26,61€	Consultar
R-453A (RS-70)	Sustitución Drop-in R-22, R-417A, R-422D, R-424A, R-438A	M / AB / POE	4,2 °C	26,48€	Consultar
R-442A (RS-50)	Sustitución Drop-in R-404A, R-507	POE	4,6 °C	28,32€	Consultar
R-449A (XP40)	Sustitución Drop-in R-404A, R-507	POE	4,5 °C	20,94€	Consultar
R-448A (N40)	Sustitución Drop-in R-404A, R-507	POE	4,5 °C	20,79€	Consultar
R-452A (XP44)	Sustitución Drop-in R-404A, R-507	POE	3,5 °C	32,09€	Consultar
R-600a	-	M / AB / POE	0 °C	-€	Consultar
R-290	-	M / AB / POE	0 °C	-€	Consultar
R-32	Alternativa R-410A	POE	0 °C	10,13€	Consultar
R-1234YF	Alternativa R-134A	POE	0 °C	-€	Consultar

TIPOS DE ENVASE

Envase	61L	27,2L	14,5L	12L	6L	12L Inflamable	6L Inflamable
€	115 €	80 €	50 €	50 €	45 €	75 €	60 €

Refrigerante	Botella 61L	Botella 27,2L	Botella 14,5L	Botella 12L	Botella 6L	Botella 1L
R-134A	60	25	15	12	6	-
R-410A	50	20	11	10	5	-
R-407C	55	25	13	10	5	-
R-453A (RS-70)	50	20	12	10	5	-
R-442A (RS-50)	55	25	13	10	5	-
R-449A (XP40)	55	20	13	10	5	-
R-448A (N40)	55	20	13	10	5	-
R-452A (XP44)	50	20	12	10	5	-
R-600a	30	12	-	-	3	0,42
R-290	25	10	-	-	2	0,43
R-32	-	-	-	9 (Botella de 48 bar)	5 (Botella de 7L)	-
R-1234YF	50	-	10	-	5	-

*DISPONEMOS DE TODO TIPO DE GASES, NO DUDES EN CONSULTAR SI NO APARCEN EN LA TABLA

SERVICIO DE RECARGA DE GASES A GRANEL + 15 €/KL

RECUPERACIÓN

Suministro de envases y máquinas de recuperación



¡SOLICITA
PRESUPUESTO
SIN COMPROMISO!

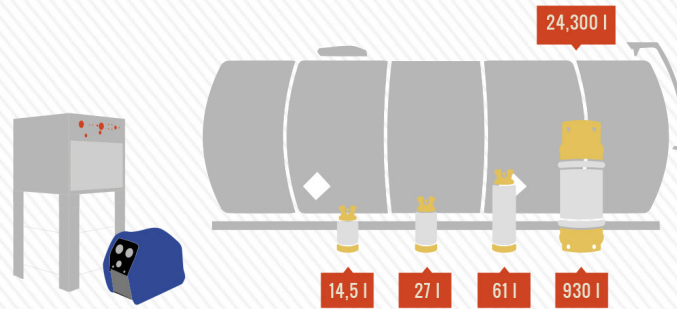

SERVICIOS DE GESTIÓN DE RESIDUOS

CONTRATO
DE ACEPTACIÓN
DE RESIDUOS



TRANSPORTE
DE RESIDUOS



Envío, transporte
y recepción del gas
a tratar

CERTIFICACIÓN
A SUS CLIENTES



REGENERACIÓN / DESTRUCCIÓN



Tratamiento de gases fluorados de efecto invernadero recuperados, con vistas a que cumplan una norma concreta de calidad (ARI 700).



Envío a una planta de incineración.
- CFC: Obligatorio.
- HCFC: Obligatorio a partir de 01/01/2015
- Mezclas HCFC + HFC (p.e.: R-22 + R-434A)

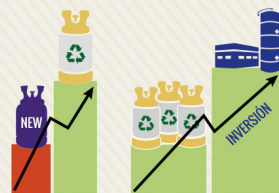

ANÁLISIS



DEVOLUCIÓN
DE IMPUESTOS

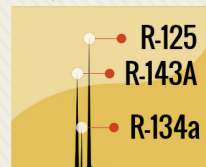

REGENERAR
DESTRUIR

Gasservei

**ES GESTOR DE
RESIDUOS AR/GRP-93
Y TRANSPORTISTA DE
RESIDUOS AR/TRP-G-93**

**BOTELLA ACETILENO**

Código	Gas	Capacidad	P.Netto
202002006	CARGA ACETILENO B05	1KG 5L	Consultar
202002606	CARGA ACETILENO B05 MINITOP	1KG 5L	Consultar
202002106	CARGA ACETILENO B10	2.1KG 10L	Consultar
202002206	CARGA ACETILENO B10 HIERRO	2.1KG 10L	Consultar
202002706	CARGA ACETILENO B10 MINITOP	2.1KG 10L	Consultar
202002306	CARGA ACETILENO B13	2.5KG 13L	Consultar
301000702	ENVASE+CARGA ACETILENO B05	5L	356,00 €
301003002	ENVASE+CARGA ACETILENO B05 MINITOP	5L	490,00 €
301000802	ENVASE+CARGA ACETILENO B10	10L	395,00 €
301003102	ENVASE+CARGA ACETILENO B10 MINITOP	10L	540,00 €
301000602	ENVASE+CARGA ACETILENO B10 HIERRO	10L	395,00 €
301000902	ENVASE+CARGA ACETILENO B13	13L	420,00 €

BOTELLA ARGÓN/MEZCLA

Código	Gas	Capacidad	P.Netto
202002806	CARGA ARGON B05	1.1M3 5L	Consultar
202003406	CARGA ARGON B05 MINITOP	1.1M3 5L	Consultar
202002906	CARGA ARGON B07	1.6M3 7L	Consultar
202003006	CARGA ARGON B10 HIERRO	2.1M3 10L	Consultar
202003106	CARGA ARGON B11	2.3M3 11L	Consultar
202003506	CARGA ARGON B11 MINITOP	2.3M3 11L	Consultar
301001702	ENVASE+CARGA ARGON B05	5L	175,00 €
301003202	ENVASE+CARGA ARGON B05 MINITOP	5L	340,00 €
301001802	ENVASE+CARGA ARGON B07	7L	195,00 €
301001602	ENVASE+CARGA ARGON B10 HIERRO	10L	250,00 €
301001902	ENVASE+CARGA ARGON B11	11L	295,00 €
301003302	ENVASE+CARGA ARGON B11 MINITOP	11L	400,00 €



202003606	CARGA MEZCLA ARGON+CO2 B05	1.2M3 5L	Consultar
202004206	CARGA MEZCLA ARGON+CO2 B05 MINITOP	1.2M3 5L	Consultar
202003806	CARGA MEZCLA ARGON+CO2 B10 HIERRO	2.3M3 10L	Consultar
202003906	CARGA MEZCLA ARGON+CO2 B11	2.5M3 11L	Consultar
202004306	CARGA MEZCLA ARGON+CO2 B11 MINITOP	2.5M3 11L	Consultar
301002102	ENVASE+CARGA MEZCLA ARGON+CO2 B05	5L	175,00 €
301003402	ENVASE+CARGA MEZCLA ARGON+CO2 B05 MINITOP	5L	340,00 €
301002002	ENVASE+CARGA MEZCLA ARGON+CO2 B10 HIERRO	10L	250,00 €
301002302	ENVASE+CARGA MEZCLA ARGON+CO2 B11	11L	295,00 €
301003502	ENVASE+CARGA MEZCLA ARGON+CO2 B11 MINITOP	11L	400,00 €

**BOTELLA NITRÓGENO**

Código	Gas	Capacidad	P.Neto
202001106	CARGA NITROGENO B05	0.9M3 5L	Consultar
202001206	CARGA NITROGENO B07	1.6M3 7L	Consultar
202001306	CARGA NITROGENO B10 HIERRO	1.9M3 10L	Consultar
202001406	CARGA NITROGENO B11	2.1M3 11L	Consultar
202001906	CARGA NITROGENO B11 MINITOP	2.1M3 11L	Consultar
202001506	CARGA NITROGENO B13	2.4M3 13L	Consultar
202001606	CARGA NITROGENO B15	3.2M3 15L	Consultar
301001102	ENVASE+CARGA NITROGENO B05	5L	150,00 €
301001202	ENVASE+CARGA NITROGENO B07	7L	170,00 €
301001002	ENVASE+CARGA NITROGENO B10 HIERRO	10L	250,00 €
301001302	ENVASE+CARGA NITROGENO B11	11L	250,00 €
301012002	ENVASE+CARGA NITROGENO B11 MINITOP	11L	350,00 €
301001402	ENVASE+CARGA NITROGENO B13	13L	250,00 €
301010502	ENVASE+CARGA NITROGENO B15	15L	295,00 €

BOTELLA OXÍGENO

Código	Gas	Capacidad	P.Neto
202000106	CARGA OXIGENO B02	0.4M3 2L	Consultar
202000206	CARGA OXIGENO B05	1.1M3 5L	Consultar
202000806	CARGA OXIGENO B05 MINITOP	1.1M3 5L	Consultar
202000306	CARGA OXIGENO B07	1.9M3 7L	Consultar
202001006	CARGA OXIGENO B10 HIERRO	2.1M3 10L	Consultar
202000406	CARGA OXIGENO B11	2.6M3 11L	Consultar
202000906	CARGA OXIGENO B11 MINITOP	2.6M3 11L	Consultar
202000506	CARGA OXIGENO B13	3.1M3 13L	Consultar
301000102	ENVASE+CARGA OXIGENO B02	2L	130,00 €
301000202	ENVASE+CARGA OXIGENO B05	5L	150,00 €
301002802	ENVASE+CARGA OXIGENO B05 MINITOP	5L	195,00 €
301000302	ENVASE+CARGA OXIGENO B07	7L	170,00 €
301000002	ENVASE+CARGA OXIGENO B10 HIERRO	10L	250,00 €
301000402	ENVASE+CARGA OXIGENO B11	11L	250,00 €
301002902	ENVASE+CARGA OXIGENO B11 MINITOP	11L	295,00 €
301000502	ENVASE+CARGA OXIGENO B13	13L	250,00 €

BOTELLA CAMPING GAS

Código	Gas	Capacidad	P.Neto
202000118	CARGA CAMPING GAS BOTELLA AZUL	1KG	7,56 €
202000218	CARGA CAMPING GAS BOTELLA AZUL	3KG	16,72 €
301010802	CARGO ENVASE VACIO CAMPING GAS	1KG	37,80 €
301010702	CARGO ENVASE VACIO CAMPING GAS	3KG	35,00 €

**EQUIPOS AUTÓNOMOS OXÍGENO/BUTANO****SUPPLYGAS®**

Código	Modelo	Botella	Soplete	Mang.	Boquilla	P.Neto
104000108	Equipo MINI Oxi-Butano B02	Oxi. B2 (2,5 L) y butano 0,5 Kg	Mod. SB-19	3 m	Mod. 1390-2N	175,00 €
104000208	Equipo MINI Oxi-Butano B05	Oxi. B5 (5 L) y butano 2,8 Kg	Mod. SB-19	3 m	Mod. 1390-2N y 4N	240,00 €
106011202	Equipo Oxi-Butano B05 MINITOP	Oxi. B5 (5 L) y butano 2,8 Kg	Mod. SB-19	5 m	Mod. 1390-2N, 4N, 6N y H	330,00 €

**EQUIPOS AUTÓNOMOS OXÍGENO/ACETILENO****SUPPLYGAS®**

Código	Modelo	Botella	Soplete	Mang.	Boquilla	P.Neto
104000308	Equipo Oxi-Acetileno B05	Oxi. B5 (5 L) y acetileno 1 Kg	Mod. SB-19	5 m	Mod. 1390-1AC y 3AC	475,00 €
106011302	Equipo Oxi-Acetileno B05 MINITOP	Oxi. B5 (5 L) y acetileno 1 Kg	Mod. SB-19	5 m	Mod. 1390-1AC y 3AC	625,00 €
106011402	Equipo Oxi-Acetileno B11	Oxi. B11 (11 L) y acetil. 1,8 Kg	Mod. SB-19	5 m	Mod. 1390-1AC y 3AC	815,00 €



Mod. 1B50



Mod. 2B50

CARROS PORTABOTELLA (1 Y 2 BOTELLAS)**SUPPLYGAS®**

Código	Modelo	Descripción	P.Neto
104020602	Carro portabotella Mod. 1B50	Ø210-240 mm. (B20, B40 o B50). Ruedas de goma Ø150mm	140,00 €
106013202	Carro portabotellas Mod. 2B50	Para 2 botellas Ø210-240 mm. (B20, B40 o B50). Ruedas de goma Ø350 mm.	158,40 €



Mod. B2



Mod. 5BP

CARROS PORTABOTELLA (EQUIPOS AUTÓNOMOS)**SUPPLYGAS®**

Código	Modelo	Descripción	P.Neto
106016002	Soporte botellas Mod. B2	Para botellas oxígeno B2 y butano 0,5 Kg	33,60 €
106013802	Carro portabotellas Mod. 5BP	Para botellas oxígeno B5 y butano 2,8 Kg	64,00 €

**SOPLETE LIGERO SOLDADURA MOD. SB-19 (TIPO HARRIS)**
-Conexiones 9/16''D x 9/16''I**SUPPLYGAS®**

Código	Modelo	P.Neto
104009102	Soplete completo Mod. SB-19 propano (empuñadura + mezclador + brazo)	50,00 €
104009202	Soplete completo Mod. SB-19 acetileno (empuñadura + mezclador + brazo)	50,00 €
109009302	Empuñadura ligera Mod. DB19	37,50 €
104009402	Mezclador propano Mod. H-19-2S	12,60 €
104009502	Mezclador acetileno Mod. H-19-2E	12,60 €
104009602	Brazo portaboquillas Mod. D-50	7,20 €

**BOQUILLAS DE CORTE MOD. 1390-N / PROPANO**

Código	Modelo	P.Neto
104021202	Boquilla soldadura Mod. 1390-0N propano	4,60 €
104009802	Boquilla soldadura Mod. 1390-1N propano	4,60 €
109009902	Boquilla soldadura Mod. 1390-2N propano	4,60 €
104010002	Boquilla soldadura Mod. 1390-3N propano	4,60 €
104010102	Boquilla soldadura Mod. 1390-4N propano	4,60 €
104010202	Boquilla soldadura Mod. 1390-5N propano	5,00 €
104010302	Boquilla soldadura Mod. 1390-6N propano	5,00 €
104010502	Boquilla soldadura Mod. 1390-8N propano	8,65 €
104019402	Boquilla multidardo Mod. 1390-H propano. Calentamiento	10,80 €

**BOQUILLAS DE CORTE MOD. 1390-AC / ACETILENO**

Código	Modelo	P.Neto
104010602	Boquilla soldadura Mod. 1390-00AC acetileno	4,60 €
104010702	Boquilla soldadura Mod. 1390-0AC acetileno	4,60 €
104010802	Boquilla soldadura Mod. 1390-1AC acetileno	4,60 €
104011002	Boquilla soldadura Mod. 1390-3AC acetileno	4,60 €
104011202	Boquilla soldadura Mod. 1390-5AC acetileno	5,00 €
104011402	Boquilla soldadura Mod. 1390-7AC acetileno	8,65 €
104011602	Boquilla soldadura Mod. 1390-9AC acetileno	8,65 €
104019502	Boquilla multidardo Mod. 1390-HA acetileno. Calentamiento	10,80 €

**SOPLETE TURBOLITE EXTREME****Castolin**

Código	Modelo	P.Neto
103000404	Kit caja de cartón con soplete + 2 botellas de GAS\Pro	85,00 €

**SOPLETE CT 27****Castolin**

Código	Modelo	P.Neto
103000504	Kit Maleta son soplete + 2 botellas de GAS\Pro	79,00 €

**SOPLETE 45090 GM****Castolin**

Código	Modelo	P.Neto
103002004	Kit caja de cartón con soplete + 2 botellas de GAS TIPO 1450	24,00 €

**SOPLETE DE CORTE AMERICANO MOD.62-4 (TIPO HARRIS)
OXÍGENO - PROPANO**

-Conexiones 9/16''D x 9/16''I

SUPPLYGAS®

Código	Modelo	Long.	Cab.	P.Neto
104003302	62-4F	460 mm	90º	79,00 €
104003602	62-4AFL	1000 mm	70º	158,00 €

**SOPLETE DE CORTE AMERICANO MOD.62-4 (TIPO HARRIS)
OXÍGENO - ACETILENO**

-Conexiones 9/16''D x 9/16''I

SUPPLYGAS®

Código	Modelo	Long.	Cab.	P.Neto
104003402	62-4	460 mm	90º	79,00 €
104003502	62-4AL	1000 mm	70º	158,00 €

**BOQUILLAS MOD. 6290-NX OXÍGENO - PROPANO**
Boquillas de corte MOD.6290 para sopletes 62-4**SUPPLYGAS®**

Código	Modelo	P.Neto
104004402	6290-2/0NX 5-10 mm	12,50 €
104004502	6290-0NX 10-15 mm	12,50 €
104004602	6290-1NX 15-25 mm	12,50 €
104004702	6290-2NX 25-50 mm	12,50 €
104004802	6290-3NX 50-100 mm	12,50 €
104004902	6290-4NX 100-175 mm	12,50 €
104005002	6290-5NX 175-250 mm	12,50 €
104005102	6290-6NX 250-300 mm	12,50 €

**BOQUILLAS MOD. 6290-AC OXÍGENO - ACETILENO**
Boquillas de corte MOD.6290 para sopletes 62-4**SUPPLYGAS®**

Código	Modelo	P.Neto
104004302	6290-2/0AC 5-10 mm	12,50 €
104005202	6290-0AC 10-15 mm	12,50 €
104005302	6290-1AC 15-25 mm	12,50 €
104005402	6290-2AC 25-50 mm	12,50 €
104005502	6290-3AC 50-100 mm	12,50 €
104005602	6290-4AC 100-175 mm	12,50 €
104005702	6290-5AC 175-250 mm	12,50 €
104005802	6290-6AC 250-300 mm	12,50 €

**VÁLVULAS ANTIRRETORNO SOPLETE (NV)****SUPPLYGAS[®]**

Código	Modelo	Gas	Conexión	Caudal	P.Neto
104013602	88-RA Soplete	Oxígeno	1/4"D	50 m3/h	15,00 €
104013702	88-LA Soplete	Gas combustible	3/8"l	15 m3/h	15,00 €
104013802	88-R Soplete	Oxígeno	9/16"D	50 m3/h	15,00 €
104013902	88-L Soplete	Gas combustible	9/16"l	15 m3/h	15,00 €

**VÁLVULAS DE SEGURIDAD ANTI-LLAMA REGULADOR (NV+FBA)****SUPPLYGAS[®]**

Código	Modelo	Gas	Conexión	Caudal	P.Neto
104014502	288-RA Regulador	Oxígeno	1/4"D	80 m3/h	16,50 €
104014602	288-LA Regulador	Gas combustible	3/8"l	30 m3/h	16,50 €
104014702	288-R Regulador	Oxígeno	9/16"D	80 m3/h	16,50 €
104014802	288-L Regulador	Gas combustible	9/16"l	30 m3/h	16,50 €

**VÁLVULAS DE SEGURIDAD ANTI-LLAMA MANGUERA (NV+FBA)****SUPPLYGAS[®]**

Código	Modelo	Gas	Conexión	Caudal	P.Neto
104015102	388-RA Manguera	Oxígeno	Ø 6/8 mm	60 m3/h	21,00 €
104015202	388-LA Manguera	Gas combustible	Ø 6/8 mm	20 m3/h	21,00 €

**MANGUERA DOBLE OXÍGENO/ACETILENO (AZUL/ROJO)****SUPPLYGAS[®]**

Código	INT/EXT	Gas	Ud/Venta	P.Neto
104001108	Ø 6+6 x 12 mm	Oxígeno / Acetileno / Propano	m	3,80 €
104001208	Ø 8+9 x 16 mm	Oxígeno / Acetileno / Propano	m	4,10 €

* A partir de 20m consultar

**ABRAZADERAS****SUPPLYGAS®**

Código	Modelo	P.Neto
106009202	Abrazadera 11-13 mm	0,65 €
106009302	Abrazadera 14-17 mm	0,65 €
106009402	Abrazadera 15-18 mm	0,65 €

**EMPALMES PARA MANGUERAS****SUPPLYGAS®**

Código	Modelo	P.Neto
106009502	Empalmes manguera Ø6 mm	2,40 €
106009602	Empalmes manguera Ø8 mm	2,40 €
106009702	Empalmes roscado 1/4" derecha	4,20 €
106009802	Empalmes roscado 3/8" izquierda	4,20 €
106009902	Empalmes roscado 9/16" derecha	4,20 €
106010002	Empalmes roscado 9/16" izquierda	4,20 €

**TUERCAS / TETINAS****SUPPLYGAS®**

Código	Modelo	P.Neto
106007402	Tuerca 1/4" derecha	1,40 €
106007602	Tuerca 3/8" derecha	2,20 €
106007702	Tuerca 3/8" izquierda	2,20 €
106007802	Tuerca 9/16" derecha	1,60 €
106007902	Tuerca 9/16" izquierda	1,60 €
106008002	Tuerca 21,8 izquierda	1,85 €
106004002	Junta goma para tuerca 21,8 izquierda	0,15 €
106008102	Tetina Ø6 mm p/tuerca 1/4"	1,80 €
106008202	Tetina Ø9 mm p/tuerca 1/4"	1,80 €
106008302	Tetina Ø6 mm p/tuerca 3/8"	2,00 €
106008402	Tetina Ø9 mm p/tuerca 3/8"	2,00 €
106008502	Tetina Ø6 mm p/tuerca 9/16"	2,00 €
106008602	Tetina Ø9 mm p/tuerca 9/16"	2,00 €
106008802	Tetina Ø5 mm p/tuerca 21,8	2,00 €
106008902	Tetina Ø6 mm p/tuerca 21,8	2,00 €

**REGULADORES 200N (200 BAR)****SUPPLYGAS®**

Código	Gas	P. Entrada	P. Salida	Caudal	C. Salida	P.Netto
106000102	Oxígeno	200 bar	10 bar	50 Nm3/h	9/16" D.	57,00 €
106000202	Acetileno	40 bar	1,4 bar	8 Nm3/h	9/16" l.	57,00 €
106000302	Nitrógeno	200 bar	10 bar	50 Nm3/h	1/4" D.	57,00 €
106000402	Propano	40 bar	4 bar	7 Nm3/h	9/16" l.	57,00 €
106000502	Argón / Mezcla	200 bar	30 L / min	25 L / min	1/4" D.	57,00 €

**REGULADORES INFLAGLOBOS - HELIO (200 BAR)****SUPPLYGAS®**

Código	Modelo	P.Netto
106001102	Inflador de globos Mod. 311-GA	63,00 €
106001202	Recambio boquilla inflador	16,00 €

**REGULADORES DIN W30X2 CON VÁLVULA DE CORTE (300 BAR)****SUPPLYGAS®**

Código	Gas	P. Entrada	P. Salida	Caudal	C. Salida	P.Netto
106000602	Oxígeno	300 bar	10 bar	50 Nm3/h	1/4" D.	72,00 €
106000702	Nitrógeno	300 bar	10 bar	50 Nm3/h	1/4" D.	72,00 €
106000802	Argón / Mezcla	300 bar	30 L / min	30 L / min	1/4" D.	72,00 €
106013102	Argón / Mezcla	300 bar	Columna	30 L / min	1/4" D.	168,00 €

**MANÓMETROS Ø 52 mm ROSCA 1/8"****SUPPLYGAS®**

Código	Escala	Rosca	Ø Esfera	P.Netto
106004102	0-2,5 bar	1/8"	52 mm	14,75 €
106004302	0-16 bar	1/8"	52 mm	14,75 €
106004402	0-40 bar	1/8"	52 mm	14,75 €
106004502	0-315 bar	1/8"	52 mm	14,75 €

**MANÓMETROS Ø 63 mm ROSCA 1/4"****SUPPLYGAS®**

Código	Escala	Rosca	Ø Esfera	P.Netto
106005502	0-2,5 bar	1/4"	63 mm	16,75 €
106005702	0-6 bar	1/4"	63 mm	16,75 €
106005802	0-16 bar	1/4"	63 mm	16,75 €
106005902	0-40 bar	1/4"	63 mm	16,75 €
106006102	0-80 bar	1/4"	63 mm	18,75 €
106006302	0-315 bar	1/4"	63 mm	16,75 €
106006202	0-400 bar	1/4"	63 mm	18,75 €
106006402	0-30 L / min	1/4"	63 mm	16,75 €

PRODUCCIÓN

Hasta **3** gO₃/h



GENERADOR DE OZONO DE PARED OP-3 PW

Código	Modelo	Producción ozono	Caudal turbinas	Medidas (mm)	P.Netto
7010003219	OP-3 PW	3 gO ₃ /h	190 m ³ /h	580 x 220 x 160	445,00 €

PRODUCCIÓN

Hasta **10** gO₃/h



GENERADOR DE OZONO DE PARED OP-10 PW

Código	Modelo	Producción ozono	Caudal turbinas	Medidas (mm)	P.Netto
7010004219	OP-10 PW	10 gO ₃ /h	190 m ³ /h	580 x 240 x 180	564,00 €

PRODUCCIÓN

Hasta **10** gO₃/h



GENERADOR DE OZONO PORTÁTIL OP-10

Código	Modelo	Producción ozono	Caudal turbinas	Medidas (mm)	P.Netto
7010005219	OP-10	10 gO ₃ /h	110 m ³ /h	220 x 170 x 260	540,00 €

PRODUCCIÓN

Hasta **20** gO₃/h



GENERADOR DE OZONO PORTÁTIL OP-20

Código	Modelo	Producción ozono	Caudal turbinas	Medidas (mm)	P.Netto
7010006219	OP-20	20 gO ₃ /h	110 m ³ /h	350 x 170 x 260	684,00 €

**SOLDADURA MIG****Punta contacto****Difusor gas****Difusor portatubo****Difusor esab****Tobera cónica****Sirga****Cuello esab****Cuello FB**

Código	Descripción	P.Neto
102006901	PUNTA CONTACTO FB15 0,6MM	0,60 €
102007001	PUNTA CONTACTO FB15 0,8MM	0,60 €
102007101	PUNTA CONTACTO FB15 1,0MM	0,60 €
102007201	PUNTA CONTACTO M6 0,8MM	0,75 €
102007301	PUNTA CONTACTO M6 1,0MM	0,75 €
102007401	PUNTA CONTACTO M6 1,2MM	0,75 €
102007601	PUNTA CONTACTO M6 1,6MM	0,75 €
102007701	PUNTA CONTACTO M8 0,8MM	0,90 €
102007801	PUNTA CONTACTO M8 1,0MM	0,90 €
102007901	PUNTA CONTACTO M8 1,2MM	0,90 €
102008101	PUNTA CONTACTO M8 1,6MM	0,90 €
102008601	PUNTA CONTACTO ESAB M6 0.8MM	1,40 €
102008701	PUNTA CONTACTO ESAB M6 1.0MM	1,40 €
102008801	PUNTA CONTACTO ESAB M6 1.2MM	1,40 €
102008901	PUNTA CONTACTO ESAB M8 0.8MM	1,40 €
102011601	PUNTA CONTACTO ESAB M8 1,6MM	1,40 €
102009001	PUNTA CONTACTO ESAB M8 1.0MM	1,40 €
102009101	PUNTA CONTACTO ESAB M8 1.2MM	1,40 €
102005201	DIFUSOR GAS BLANCO FB36	0,90 €
102005301	DIFUSOR GAS BLANCO FB501	0,90 €
102011201	DIFUSOR GAS NEGRO FB40	2,80 €
102004901	DIFUSOR PORTATUBO FB15	1,36 €
102005001	DIFUSOR PORTATUBO M6 FB25	0,84 €
102005101	DIFUSOR PORTATUBO M8 FB25	0,88 €
102009201	DIFUSOR ESAB M6 PSF-250	2,50 €
102009301	DIFUSOR ESAB M6 PSF-315	2,60 €
102009401	DIFUSOR ESAB M8 PSF-400	3,22 €
102005801	TOBERA CONICA FB15	1,76 €
102005901	TOBERA CONICA FB25	3,06 €
102006001	TOBERA CONICA FB36	4,16 €
102011101	TOBERA CONICA FB40	6,50 €
102006101	TOBERA CONICA FB501	3,84 €
102006201	SIRGA AZUL 4MT. HIERRO/INOX. 0,8 - 1,0MM	3,20 €
102006301	SIRGA ROJA 4MT. HIERRO/INOX. 1,0 - 1,2MM	3,20 €
102006401	SIRGA AMARILLA 4MT. HIERRO/INOX. 1,2 - 1,6MM	3,20 €
102011501	SIRGA COMBINADA TEFLON/METAL GRIS 4MT	9,60 €
102006601	SIRGA TEFLON AZUL ALUMINIO 4MT. 0,8 - 1,0MM	19,77 €
102006701	SIRGA TEFLON ROJO ALUMINIO 4MT 1,0 - 1,2MM	19,77 €
102006801	SIRGA TEFLON AMARILLO ALUMINIO 4MT 1,2 - 1,6MM	19,77 €
106006701	CUELLO ESAB PSF-250	10,88 €
106006801	CUELLO ESAB PSF-315	11,79 €
106006901	CUELLO ESAB PSF-400	13,60 €
102004501	CUELLO FB15	4,54 €
102004601	CUELLO FB25	12,80 €
102004701	CUELLO FB36	13,58 €
102004801	CUELLO FB501	39,68 €
106006601	CUELLO FB620W	Consultar

**SOLDADURA MIG****Antorcha FB**

Código	Descripción	P.Netto
102011701	ANTORCHA FB15 3MT. ALUMINIO	38,53 €
102003901	ANTORCHA FB15 4MT.	38,53 €
102011801	ANTORCHA FB25 3MT. ALUMINIO	51,10 €
102004001	ANTORCHA FB25 4MT.	51,10 €
102004201	ANTORCHA FB36 REFORZADA 4MT.	72,80 €
102004202	ANTORCHA FB36 REFORZADA Mod. Mar 3mts	72,80 €
102011001	ANTORCHA FB40 4MT.	150,00 €
102012101	ANTORCHA FB501 3MT. ALUMINIO REFRIGERADA	114,80 €
102004301	ANTORCHA FB501 REFRIGERADA 4MT.	106,40 €
102011401	ANTORCHA FB620W REFRIGERADA 4MT.	161,00 €

SOLDADURA TIG**Cabezal****Difusor SR****Pinza portatugsteno SR****Tapa SR****Tobera cerámica**

Código	Descripción	P.Netto
101001401	CABEZAL SR17	7,92 €
101001301	CABEZAL SR17V VALVULA	9,02 €
101001601	CABEZAL SR26	10,56 €
101001501	CABEZAL SR26V VALVULA	12,10 €
101003101	DIFUSOR SR 1,0MM	1,15 €
101003201	DIFUSOR SR 1,6MM	1,15 €
101003301	DIFUSOR SR 2,0MM	1,15 €
101003401	DIFUSOR SR 2,4MM	1,15 €
101003501	DIFUSOR SR 3,2MM	1,15 €
101003601	DIFUSOR SR 4,0MM	1,15 €
101002501	PINZA PORTATUGSTENO SR 1,0MM	0,75 €
101002601	PINZA PORTATUGSTENO SR 1,6MM	0,75 €
101002701	PINZA PORTATUGSTENO SR 2,0MM	0,75 €
101002801	PINZA PORTATUGSTENO SR 2,4MM	0,75 €
101002901	PINZA PORTATUGSTENO SR 3,2MM	0,75 €
101003001	PINZA PORTATUGSTENO SR 4,0MM	0,75 €
101003801	TAPA CORTA SR	1,25 €
101003701	TAPA LARGA SR	1,50 €
101002201	TOBERA CERAMICA SR Nº 4	1,20 €
101002101	TOBERA CERAMICA SR Nº 5	1,20 €
101002001	TOBERA CERAMICA SR Nº 6	1,20 €
101001901	TOBERA CERAMICA SR Nº 7	1,20 €
101001801	TOBERA CERAMICA SR Nº 8	1,20 €
101001701	TOBERA CERAMICA SR Nº 10	1,20 €

**SOLDADURA TIG****Antorcha SR**

Código	Descripción	P.Neto
101000601	ANTORCHA SR17E 4MT.	60,21 €
101000701	ANTORCHA SR17E 8MT.	83,77 €
101000201	ANTORCHA SR17V VALVULA 4MT.	49,28 €
101000301	ANTORCHA SR17V VALVULA 8MT.	69,00 €
101001001	ANTORCHA SR18 4MT. REFRIGERADA	140,98 €
101000801	ANTORCHA SR26E 4MT.	75,07 €
101000901	ANTORCHA SR26E 8MT.	113,34 €
101000101	ANTORCHA SR26V VALVULA 4MT.	66,99 €
101000501	ANTORCHA SR26V VALVULA 8MT.	99,70 €

Pinza masa

Código	Descripción	P.Neto
103000701	PINZA MASA 250A	2,79 €
103000801	PINZA MASA 400A	5,55 €
103001001	PINZA MASA DE MORDAZA 600A	11,48 €

Pinza portaelectrodos

Código	Descripción	P.Neto
103000401	PINZA PORTAELECTRODOS 300A	8,78 €
103000501	PINZA PORTAELECTRODOS 400A	10,78 €
103000601	PINZA PORTAELECTRODOS 500A	11,14 €

Pantalla automática

Código	Descripción	P.Neto
106003107	PANTALLA AUTOMATICA PROFISHELL ONE SAFETOP	26,18 €
106000807	PANTALLA AUTOMATICA PROFISHELL SAFETOP	51,66 €
106003007	PANTALLA AUTOMATICA AUTOSHELL PLUS-EVO	64,26 €
106003807	PANTALLA AUTOMATICA PROFILIGHT SAFETOP	111,44 €



ACCESORIOS SOLDADURA

Conectores



Spray antiproyecciones



Electrodos tugsteno

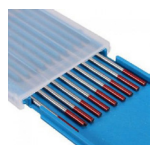

Código	Descripción	P.Neto
103001101	CONECTOR AEREO MACHO 10/25	2,85 €
103001201	CONECTOR AEREO MACHO 35/50	5,19 €
103001301	CONECTOR AEREO MACHO 50/70	6,68 €
103001401	CONECTOR AEREO MACHO 70/95	7,83 €
106005701	CONECTOR AEREO MACHO ESPECIAL 10/25	13,32 €
106005601	CONECTOR AEREO MACHO ESPECIAL 35/50	15,69 €
103001501	CONECTOR AEREO HEMBRA 10/25	2,85 €
103001601	CONECTOR AEREO HEMBRA 35/50	5,16 €
103001701	CONECTOR AEREO HEMBRA 50/70	5,97 €
103001801	CONECTOR AEREO HEMBRA 70/95	7,82 €
103001901	CONECTOR BASE MACHO 10/25	3,36 €
103002001	CONECTOR BASE MACHO 35/50	5,67 €
103002101	CONECTOR BASE MACHO 50/70	6,52 €
103002201	CONECTOR BASE HEMBRA 10/25	3,36 €
103002301	CONECTOR BASE HEMBRA 35/50	5,67 €
103002401	CONECTOR BASE HEMBRA 50/70	6,52 €
106000501	SPRAY ANTIPROYECCIONES SOLDADURA	3,50 €
101003901	ELECTRODO TUGSTENO ROJO 2% Th 1,0MM	1,00 €
101004001	ELECTRODO TUGSTENO ROJO 2% Th 1,6MM	1,30 €
101004101	ELECTRODO TUGSTENO ROJO 2% Th 2,0MM	2,38 €
101004201	ELECTRODO TUGSTENO ROJO 2% Th 2,4MM	2,74 €
101004301	ELECTRODO TUGSTENO ROJO 2% Th 3,2MM	5,39 €
101004401	ELECTRODO TUGSTENO ROJO 2% Th 4,0MM	8,49 €
101006001	ELECTRODO TUGSTENO VERDE PURO 1,0MM	1,00 €
101006101	ELECTRODO TUGSTENO VERDE PURO 1,6MM	1,30 €
101006201	ELECTRODO TUGSTENO VERDE PURO 2,0MM	2,38 €
101006301	ELECTRODO TUGSTENO VERDE PURO 2,4MM	2,74 €
101006401	ELECTRODO TUGSTENO VERDE PURO 3,2MM	5,39 €
101006501	ELECTRODO TUGSTENO VERDE PURO 4,0MM	8,49 €
101008201	ELECTRODO TUGSTENO DORADO 1,5% La 1.0MM	1,12 €
101008301	ELECTRODO TUGSTENO DORADO 1,5% La 1.6MM	1,44 €
101008401	ELECTRODO TUGSTENO DORADO 1,5% La 2.0MM	2,42 €
101008501	ELECTRODO TUGSTENO DORADO 1,5% La 2.4MM	3,08 €
101008601	ELECTRODO TUGSTENO DORADO 1,5% La 3.2MM	5,99 €
101008701	ELECTRODO TUGSTENO DORADO 1,5% La 4.0MM	9,43 €
101008801	ELECTRODO TUGSTENO TURQUESA-VIOLETA 1.0MM	1,12 €
101008901	ELECTRODO TUGSTENO TURQUESA-VIOLETA 1.6MM	1,44 €
101009001	ELECTRODO TUGSTENO TURQUESA-VIOLETA 2.0MM	2,42 €
101009101	ELECTRODO TUGSTENO TURQUESA-VIOLETA 2.4MM	3,08 €
101009201	ELECTRODO TUGSTENO TURQUESA-VIOLETA 3.2MM	5,99 €
101009301	ELECTRODO TUGSTENO TURQUESA-VIOLETA 4.0MM	9,43 €



APORTACIONES SOLDADURA

Varillas



Electrodos



Código	Descripción	P.Netto
101001404	VARILLA CASTOTIG ACERO AL CARBONO 2.0MM	Consultar
101001904	VARILLA CASTOTIG ACERO AL CARBONO 3,2MM	Consultar
101001804	VARILLA CASTOTIG ACEROS DUPLEX 2.0MM	Consultar
101000704	VARILLA CASTOTIG ALUMINIO/MAGNESIO 5% 1.0MM	Consultar
101000804	VARILLA CASTOTIG ALUMINIO/MAGNESIO 5% 1.2MM	Consultar
101000904	VARILLA CASTOTIG ALUMINIO/MAGNESIO 5% 1.6MM	Consultar
101001004	VARILLA CASTOTIG ALUMINIO/MAGNESIO 5% 2.0MM	Consultar
101001104	VARILLA CASTOTIG ALUMINIO/MAGNESIO 5% 2.5MM	Consultar
101001204	VARILLA CASTOTIG ALUMINIO/MAGNESIO 5% 3.2MM	Consultar
101009401	VARILLA CASTOTIG ALUMINIO/SILICIO 5% 3.2MM	Consultar
101000104	VARILLA CASTOTIG INOX. 316L 1.0MM	Consultar
101000304	VARILLA CASTOTIG INOX. 316L 1.6MM	Consultar
101000404	VARILLA CASTOTIG INOX. 316L 2.0MM	Consultar
101000504	VARILLA CASTOTIG INOX. 316L 2.5MM	Consultar
101000604	VARILLA CASTOTIG INOX. 316L 3.2MM	Consultar
101001304	VARILLA CASTOTIG LATON 2.0MM	Consultar
105003605	VARILLA LATON 1.5MMX500MM CASTOLIN	Consultar
103001003	ELECTRODO RUTILO OMNIA 46 1.6 x 250MM (PACK 130ud.)	Consultar
103000203	ELECTRODO RUTILO OMNIA 46 2.5 x 350MM (PACK 250ud.)	Consultar
103000303	ELECTRODO RUTILO OMNIA 46 3.2 x 350MM (PACK 175ud.)	Consultar
103000403	ELECTRODO RUTILO OMNIA 46 4.0 x 350MM (PACK 110ud.)	Consultar
102000704	ELECTRODO RUTILO CASTOMAG 2.5 x 350MM	Consultar
102000804	ELECTRODO RUTILO CASTOMAG 3.2 x 350MM	Consultar
102000904	ELECTRODO RUTILO CASTOMAG 4.0 x 350MM	Consultar
103000503	ELECTRODO BASICO VANDAL 7018 2.5 x 350MM (PACK 118ud.)	Consultar
103000603	ELECTRODO BASICO VANDAL 7018 3.2 x 350MM (PACK 73ud.)	Consultar
102001004	ELECTRODO BASICO CASTOMAG 2.5 x 350MM	Consultar
102001104	ELECTRODO BASICO CASTOMAG 3.2 x 350MM	Consultar
102002304	ELECTRODO CASTOMAG 7016 2,5 x 350MM (6666N)	Consultar
102002404	ELECTRODO CASTOMAG 7016 3,2 x 350MM (6666N)	Consultar
102002504	ELECTRODO CASTOMAG FERRO-NIQUEL (7330D)3,2 x 350MM	Consultar
102001904	ELECTRODO FUNDICION EutecTrode® 224 3,2 x 350MM (PAQ. 5,0Kg)	Consultar
103001103	ELECTRODO INOX. LIMAROSTA 316L 1.5 x 250MM (PACK 140ud.)	Consultar
103000703	ELECTRODO INOX. LIMAROSTA 316L 2.0 x 300MM (PACK 200ud.)	Consultar
103000803	ELECTRODO INOX. LIMAROSTA 316L 2.5 x 350MM (PACK 120ud.)	Consultar
103000903	ELECTRODO INOX. LIMAROSTA 316L 3.2 x 350MM (PACK 80ud.)	Consultar
102001204	ELECTRODO INOX 316L CASTOMAG 2.0 x 350MM	Consultar
102001304	ELECTRODO INOX 316L CASTOMAG 2.5 x 350MM	Consultar
102001404	ELECTRODO INOX 316L CASTOMAG 3.2 x 350MM	Consultar
103003603	ELECTRODO LINOX 308L 2.0 x 300MM PACK 196	Consultar
103003503	ELECTRODO LINOX 308L 2.5 x 350MM PACK 200	Consultar
103003703	ELECTRODO LINOX 308L 3.2 x 350MM PACK 196	Consultar

APORTACIONES SOLDADURA

Hilos



Código	Descripción	P.Neto
102000504	HILO CASTOMIG ALUMINIO/MAGNESIO 5% 1.0MM (1 x 7,5kg)	Consultar
102000604	HILO CASTOMIG ALUMINIO/MAGNESIO 5% 1.2MM (1 x 7,5kg)	Consultar
102001704	HILO CASTOMIG ALUMINIO/SILICIO 5% 1.2MM (1 x 7,5kg)	Consultar
102001804	HILO CASTOMIG INOX 308L 1.0MM (1 x 15kg)	Consultar
102000104	HILO CASTOMIG INOX 316L 0.8MM (1 x 15kg)	Consultar
102000204	HILO CASTOMIG INOX 316L 1.0MM (1 x 15kg)	Consultar
102000304	HILO CASTOMIG INOX 316L 1.2MM (1 x 15kg)	Consultar
102001003	HILO COBRE/SILICIO CuSi 0.8MM (1 x 5kg)	Consultar
102001203	HILO HIERRO MIG 0.6MM (1 x 5kg) NEUTRO	Consultar
102001303	HILO HIERRO MIG 0,8MM (1 x 5kg) NEUTRO	Consultar
102000703	HILO HIERRO MIG 0.8MM (1 x 15kg) NEUTRO	Consultar
102000803	HILO HIERRO MIG 1.0MM (1 x 15kg) NEUTRO	Consultar
102000903	HILO HIERRO MIG 1.2MM (1 x 15kg) NEUTRO	Consultar

MAQUINARIA SOLDADURA



Código	Descripción	P.Neto
401000304	MAQUINA SOLDAR MINI COMPACTA DERBY 181 CASTOLIN	595,00 €



401000104	MAQUINA SOLDAR COMPACTA DERBY 305 CASTOLIN	1.250,00 €
-----------	--	-------------------



401000204	MAQUINA SOLDAR INVERTER ARC 160 CASTOLIN COMPLETA C/MALETIN	170,00 €
-----------	---	-----------------



MAQUINARIA SOLDADURA



Código	Descripción	P.Neto
401000303	MAQUINA SOLDAR POWERTEC 305C LINCOLN	990,00 €



401000403	MAQUINA SOLDAR Speedtec® 505SP - Pulse LINCOLN	4.500,00 €
-----------	--	------------

MAQUINARIA SOLDADURA



Código	Descripción	P.Neto
106000401	MAQUINA SOLDAR INVERTER 200Amp COMPLETA C/MALETIN FERBESOL	199,00 €



401000803	MAQUINA SOLDAR INVERTER TIG 200Amp HF FERBESOL	540,00 €
-----------	--	----------



106002201	MAQUINA INVERTER TIG AC/DC 200 AMP. PULSADA FERBESOL	910,00 €
-----------	--	----------

MESSER 
Gases for Life

「DISTRIBUIDOR」





Gases para soldadura y corte

Ferroline C6X1

Ferroline C12X2

Helio

Inoxline C2

Formiergas H5

Oxígeno

Argón

Nitrógeno



Gases alimentarios

Gourmet C (E290)

Gourmet N (E941)

Gourmet N50 (E941 / E290)

Gourmet N70 (E941 / E290)

Gourmet N80 (E941 / E290)



Gases medicinales

Oxígeno líquido medicinal

Aire sintético medicinal

Protóxido de nitrógeno medicinal

Dióxido de carbono medicinal

Óxido nítrico medicinal

Nitrógeno líquido medicinal



Gases submarinismo

Helio

Oxígeno

Nitrógeno



Aplicaciones especiales

Helio balloon gas

Hielo seco (pellets de 3 a 16 mm)

Nitrógeno líquido



Disponemos de todo tipo de gases, para más modelos consultar.
Desde 5 L hasta bloques de 18 botellas de 50 L.



Calle Trueno, 141, 03006 Pol. Ind. Pla de la Vallonga, Alicante
965 28 79 45
gasesfuensanta@gasesfuensanta.es

